

APC™

by **Schneider Electric**

Installation and Operation

Smart-UPS™

SUA2200/3000 UXI

230 VAC

Tower

Uninterruptible Power Supply

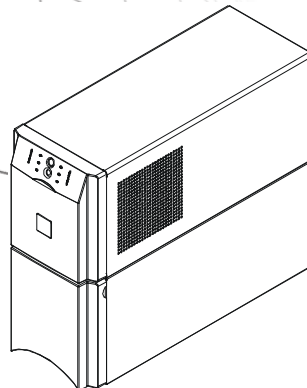

Important Safety Information

Read the instructions carefully to become familiar with the equipment before trying to install, operate, service or maintain it. The following special messages may appear throughout this manual or on the equipment to warn of potential hazards or to call attention to information that clarifies or simplifies a procedure.

The addition of this symbol to a Danger or Warning safety label indicates that an electrical hazard exists which will result in personal injury if the instructions are not followed.



This is the safety alert symbol. It is used to alert you to potential personal injury hazards. Obey all safety messages that follow this symbol to avoid possible injury or death.

WARNING

WARNING indicates a potentially hazardous situation which, if not avoided, **can result in** death or serious injury.

CAUTION

CAUTION indicates a potentially hazardous situation which, if not avoided, **can result in** minor or moderate injury.

NOTICE

NOTICE used to address practices not related to physical injury. The safety alert symbol is not used with this signal word.

Safety and General Information

Inspect the package contents upon receipt. Notify the carrier and dealer if there is any damage.

- This UPS is for indoor use only.
- Do not operate this UPS in direct sunlight, in contact with fluids, or where there is excessive dust or high humidity.
- Do not operate the UPS near open windows or doors.
- Be sure the air vents on the UPS are not blocked. Allow adequate space for proper ventilation.
Note: Allow a minimum of 20 cm clearance on both front and rear sides of the UPS.
- Environmental factors impact battery life. Elevated ambient temperatures, poor quality utility power, and frequent discharges will shorten battery life. Follow the battery manufacturer recommendations.

Introduction

About this UPS

The APC™ by Schneider Electric Smart-UPS™ is a high performance uninterruptible power supply (UPS). The UPS provides protection for electronic equipment from utility power blackouts, brownouts, sags, surges, small utility power fluctuations and large disturbances. The UPS also provides battery backup power for connected equipment until utility power returns to acceptable levels or the batteries are fully discharged.

This user manual is available on the APC by Schneider Electric web site, www.apc.com.

Package contents

Read the Safety Guide before installing the UPS.

The model and serial numbers for all units are located on the rear panel. See the small label with numbers and bar codes.

The packaging is recyclable; save it for reuse or dispose of it properly.

Check the package contents:

- UPS
- Battery cable assembly
- IEC jumper cables
- Input power cord
- Serial cable
- USB cable
- EPO connector
- Utility connector plug
- User Manual
- Safety Guide
- Warranty Card

Specifications

Temperature Operating	0° C to 40° C (32° F to 104° F)	This unit is intended for indoor use only. Select a location sturdy enough to handle the weight. Do not operate the UPS where there is excessive dust or the temperature or humidity are outside the specified limits. Ensure that the air vents on the UPS are not blocked. Environmental factors impact battery life. High temperatures, poor utility power, and frequent, short duration discharges will shorten battery life.
Maximum Elevation Operating Storage	3,000 m (10,000 ft) 15,240 m (50,000 ft)	
Humidity	0 to 95% relative humidity, non-condensing	
Weight	36 kg (80 lbs)	
The model and serial numbers for all units are located on the rear panel. For some models, an additional label is located on the unit chassis behind the front bezel.		

Installation

Connect the Batteries

An APC by Schneider Electric external battery pack can be used with this unit. Refer to the APC by Schneider Electric Web site www.apc.com, or contact your dealer for information regarding APC by Schneider Electric external battery packs.

Third Party Battery Solution

When using a non-APC battery pack, a 48 V battery string should be wired to the UPS using the supplied battery cable assembly.

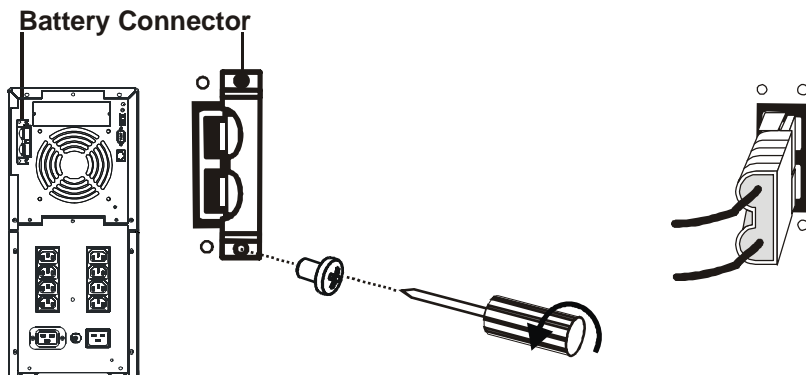

A 140 Amp fuse must be used between the connector cable and the batteries. If parallel strings of batteries are used, each string of four 12 Volt batteries must be provided with an 80 to 140 Amp fuse or fusible link to provide protection in the event of a short circuit.

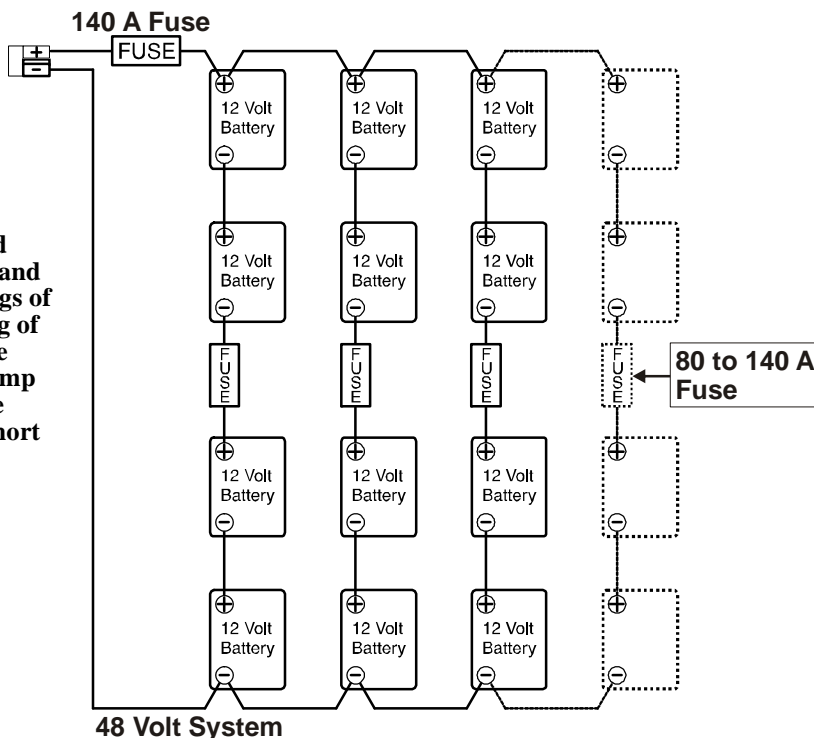

Accessories (Optional)

The UPS is equipped with an accessory SmartSlot. Refer to the APC by Schneider Electric Web site www.apc.com, for available accessories.

Install accessories prior to connecting power to the UPS.

For additional computer system security, install PowerChute™ *Business Edition* software. This provides automatic, unattended shutdown capabilities on most major network operating systems.

Connect Equipment and Power to the UPS

1. The UPS features a transient voltage surge-suppression (TVSS) screw located on the rear panel, for connecting the ground lead on surge suppression devices such as telephone and network line protectors.

NOTE: Prior to connecting the grounding cable, ensure that the UPS is NOT connected to utility or battery power.

2. Connect equipment to the UPS.
3. Add optional accessories to the Smart-Slot.
4. Plug the UPS into a two-pole, three-wire, grounded receptacle only. Avoid using extension cords. The utility power cord is supplied in the UPS literature kit.

NOTE: Prior to connecting the utility power, connect the ground lead (optional) to the TVSS screw.

5. Turn on all connected equipment. To use the UPS as a master on/off switch. Be sure all connected equipment is switched on.
6. A runtime calibration is required at initial start-up, when additional batteries are added, old batteries are replaced or if the estimated runtime is found to be inaccurate.
Do not use old batteries (two or more years old), and new batteries together.
Refer to the *Perform a UPS Runtime Calibration* section in this manual for calibration criteria.

Install PowerChute™ software

To install PCPE, connect the supplied USB cable between the data port on the UPS and to a computer with access to the Web.

On the computer, go to www.apc.com/tools/download. Select Software Upgrades - PowerChute Personal Edition and the appropriate operating system. Follow directions to download the software.

Program the UPS for the Number of External Batteries

Option 1: Using PowerChute™ *Business Edition*

Install PowerChute™ software. Reboot the computer, and then access the PowerChute *Business Edition* graphical user interface (GUI). Follow these steps:

1. From the PowerChute main menu select the UPS to be programmed.
2. Right mouse click on the selected UPS and select Properties.
3. Select the General tab, then the Battery Status tab.
4. In the Battery Pack Count field, enter the number of batteries to be used.
5. Select **Apply**.
 - 0 batteries = 17 A hrs
 - 1 battery = 51 A hrs
 - 2 batteries = 85 A hrs

Option 2: Using a terminal program

If a USB port is used, disconnect the USB cable. Connect a Serial cable to the Serial port. Continue programming by skipping to step two below.

When using a Serial port:

1. **EXIT** the PowerChute *Business Edition* server if running. In Windows NT, the UPS service must be stopped.
2. Open a terminal program. Example: Hyperterminal in Windows NT.
From the Desktop, go to **Start => Programs => Accessories => Hyperterminal**.
3. Double-click on the **Hyperterminal** icon.
 - Follow the prompts to choose a name and an icon. Disregard the message, "...must install a modem," if it is displayed. Select **OK**.
 - Select the COM port connected to the UPS. The port settings are:
 - bits per second - 2400
 - data - 8 bits
 - parity - none
 - stop bit - 1
 - flow control - none
4. A terminal window will open. Follow these steps to enter the number of external battery packs (or equivalent A hrs), connected to the UPS:
 - a. Press the **Y** key to initiate terminal mode. The UPS responds **SM**.
 - b. Press **>** to indicate and modify the number of battery packs.
 - c. Press **+** or **-** until the number selected is closest to the A hr (at 48 V) of the connected batteries. Each step adds 34 A hrs.
 - 0 batteries = 17 A hrs
 - 1 battery = 51 A hrs
 - 2 batteries = 85 A hrs
5. Press **R** to end the communication with the UPS. The UPS will respond **BYE**.

Operation

Start the UPS

1. Press the  button on the front panel to start the UPS.
2. For optimal computer system security, install PowerChute Smart-UPS monitoring software.

The UPS charges the batteries during normal operation on utility power. *Do not* expect full run capability during the initial charge period. The initial charge period depends on the number and type of batteries used.

Connect the UPS to the Network (if Applicable)

Communication Ports

SERIAL PORT

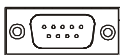

USB PORT



Use only the supplied cable to connect to the serial port. A standard serial interface cable is incompatible with the UPS.

Serial and USB ports cannot be used simultaneously.

Emergency Power Off

The emergency power off (EPO) feature is user configurable. EPO provides immediate de-energizing of connected equipment from a remote location, without switching to battery operation.

1. Use the EPO connector supplied with the UPS.
2. Use a normally-open contact to connect the +24 terminal to the IN terminal.
3. Wire the four-pin connector to the EPO system.

EPO PORT
(located on rear panel)



EPO Connector

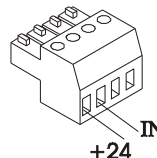

The EPO interface is a Safety Extra Low Voltage (SELV) circuit. Connect it only to other SELV circuits. The EPO interface monitors circuits that have no determined voltage potential. Such closure circuits may be provided by a switch or relay properly isolated from the utility. To avoid damage to the UPS, do not connect the EPO interface to any circuit other than a closure type circuit.

To connect the UPS to the EPO switch, use standard low voltage cable in accordance with national and local regulations.

Perform a UPS Runtime Calibration

Runtime calibration criteria

- All connected batteries must be fully charged. The UPS must show battery capacity at 100%.
- The load connected to the UPS should not vary more than 5% during calibration.
- If utility power supply is interrupted during calibration, the process will abort. Perform a runtime calibration once the utility power has been restored.

NOTE: The number of external batteries connected to the UPS will influence the time it takes to perform a runtime calibration.

Option 1: Using PowerChute *Business Edition*

1. From the PowerChute main menu select the UPS to be programmed.
2. Right mouse click on the selected UPS and select Properties.
3. Select the Diagnostics tab.
4. Select Start Calibration.

During the runtime calibration the UPS will operate on battery power. Stopping the calibration process will cause the system to abort the runtime calibration.

Option 2: Using a terminal program

If a USB port is used, disconnect the USB cable. Connect a Serial cable to the Serial port. Continue programming by skipping to step two below.

When using a Serial port:



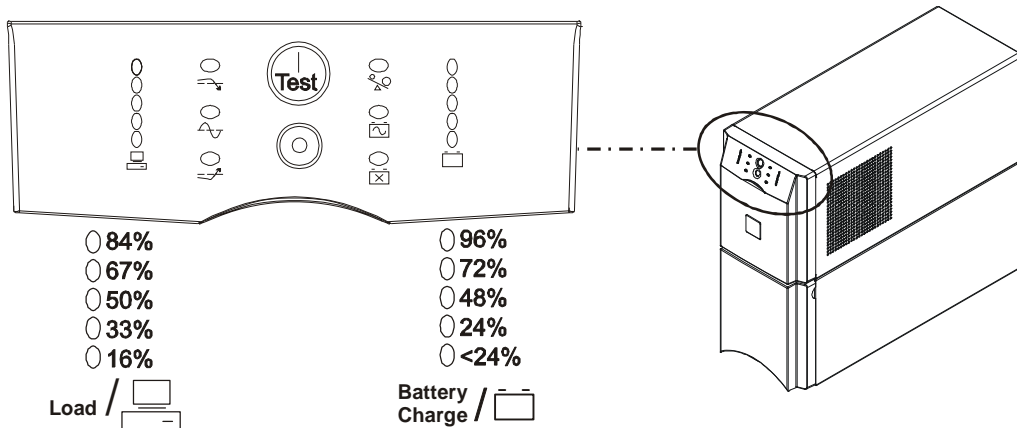

1. **EXIT** the PowerChute *Business Edition* server if running. In Windows NT, the UPS service must be stopped.
2. Open a terminal program. Example: Hyperterminal in Windows NT.
From the Desktop, go to **Start => Programs => Accessories => Hyperterminal**.
3. Double-click on the **Hyperterminal** icon.
 - Follow the prompts to choose a name and an icon. Disregard the message, "...must install a modem," if it is displayed. Select **OK**.
 - Select the COM port connected to the UPS. The port settings are:
 - bits per second - 2400
 - data - 8 bits
 - parity - none
 - stop bit - 1
 - flow control - none
4. A terminal window will open. Follow these steps to enter the number of external battery packs (or equivalent A hrs), connected to the UPS:
 - a. Press the **Y** key to initiate terminal mode. The UPS responds **SM**.
 - b. Press **D** to start the UPS runtime calibration. The UPS will respond **OK**. If the UPS responds **NA**, check to ensure that all of the runtime calibration criteria are met. Refer to the *Runtime calibration criteria* section above.
 - c. The UPS will operate on battery power during the runtime calibration, and return to utility power operation when the calibration is concluded.
 - d. Press **R** to end the communication with the UPS. The UPS will respond **BYE**.

Display Panel



Display Panel Indicators and Function Buttons





Indicator LED	Indicator Title	Description
	On Line	The UPS is supplying utility power to the connected equipment, (see <i>Troubleshooting</i>).
	AVR Trim	The UPS is compensating for a high utility voltage.
	AVR Boost	The UPS is compensating for a low utility voltage.
	On Battery	The UPS is supplying battery power to the connected equipment.
	Overload	The connected equipment is drawing more than the UPS power rating allows, (see <i>Troubleshooting</i>).
	Replace Battery/ Battery Disconnected	The battery is disconnected or must be replaced, (see <i>Troubleshooting</i>).
<ul style="list-style-type: none"> ○ 266 ○ 248 ○ 229 ○ 210 ○ 191 	Diagnostic Utility Voltage	<p>The UPS has a diagnostic feature that indicates the utility voltage. The UPS starts a self-test as part of this procedure. The self-test does not affect the voltage display.</p> <p>Press and hold the button to view the utility voltage bar graph indicator.</p> <p>After a few seconds, this five-LED <i>Battery Charge</i> indicator on the right of the display panel will show the utility input voltage.</p> <p>Refer to the figure on the left for the voltage reading, (values are not listed on the UPS).</p> <p>The indicator on the UPS shows the voltage is between the displayed value on the list and the next higher value, (see <i>Troubleshooting</i>).</p>







Feature Button	Feature Title	Function
	Power On	Press this button to turn on the UPS. Continue reading for additional capabilities.
	Power Off	Press this button to turn off the UPS.
	Self-Test	<p>Automatic: The UPS performs a self-test automatically when tuned on, and every two weeks thereafter (by default). During the self-test, the UPS briefly operates the connected equipment on battery.</p> <p>Manual: Press and hold the  button for a few seconds to initiate the self-test.</p>
	Cold Start	When there is no utility power and the UPS is off, the cold start feature will switch the UPS and connected equipment onto battery power, (see <i>Troubleshooting</i>).

Configuration

UPS settings



Settings are adjusted through PowerChute software or optional Smart Slot accessory cards.

Function	Factory Default	User Selectable Choices	Description
Automatic Self-Test	Every 14 days (336 hours)	<ul style="list-style-type: none"> • Every 7 days (168 hours) • On start up only • No self-test 	Set the interval at which the UPS will execute a self-test.
UPS ID	UPS_IDEN	Up to eight characters (alphanumeric)	Uniquely identify the UPS, (i.e. server name or location) for network management purposes.
Voltage Sensitivity The UPS detects and reacts to line voltage distortions by transferring to battery operation to protect the connected equipment.	High sensitivity 	 Brightly illuminated: high sensitivity  Dimly illuminated: medium sensitivity  No illumination: low sensitivity	Adjust by pressing the <i>VOLTAGE SENSITIVITY</i> switch  (rear panel). Use a pointed object, (such as a pen) to do so. Voltage sensitivity levels can be changed through PowerChute software. Note: In situations of poor power quality, the UPS may frequently transfer to battery operation. If the connected equipment can operate normally under such conditions, reduce the sensitivity setting to conserve battery capacity and service life.
Alarm Delay Control	Enable	<ul style="list-style-type: none"> • Enable • Mute • Disable 	Mute ongoing audible alarms or disable all audible alarms permanently.
Shutdown Delay	90 seconds	<ul style="list-style-type: none"> • 0 s • 90 s • 180 s • 270 s • 360 s • 450 s • 540 s • 630 s 	Set the interval between the time when the UPS receives a shutdown command and actual shutdown.

Function	Factory Default	User Selectable Choices	Description
Low Battery Alert	 2 minutes PowerChute software interface provides automatic, unattended shutdown when approximately two minutes of battery operated run time remains.	 <i>Brightly illuminated:</i> low battery alert level of about 2 minutes  <i>Dimly illuminated:</i> low battery alert level of about 5 minutes  <i>No illumination:</i> low battery alert level is about 8 minutes	The low battery alert beeps are continuous when two minutes of run time remain. To change the default interval setting, use a pointed object such as a pen to press the <i>VOLTAGE SENSITIVITY</i> switch  (rear panel), while pressing the  button, (front display). Change the low battery alert interval setting to the time that the operating system or system software requires to shut down.
Synchronized Turn-on Delay	0 seconds	<ul style="list-style-type: none"> • 0 s • 60 s • 120 s • 180 s • 240 s • 300 s • 360 s • 420 s 	Specify the time the UPS will wait after the return of utility power before start up, (to avoid branch circuit overload).
High Transfer Point	253 VAC	<ul style="list-style-type: none"> • 253 VAC • 257 VAC • 261 VAC • 265 VAC 	To avoid unnecessary use of the battery where utility voltage is chronically high, set the high transfer point higher if the connected equipment can tolerate this condition.
Low Transfer Point	208 VAC	<ul style="list-style-type: none"> • 196 VAC • 200 VAC • 204 VAC • 208 VAC 	To avoid unnecessary use of the battery where utility voltage is chronically low, set the low transfer point lower if the connected equipment can tolerate this condition.
Output Voltage	230 VAC	<ul style="list-style-type: none"> • 220 VAC • 230 VAC • 240 VAC 	Sets the output voltage of the UPS.

Troubleshooting

Use this chart to solve minor UPS installation and operation problems. Refer to www.apc.com with complex UPS problems.

Problem and/or Possible Cause	Solution
UPS will not turn on	
 button not pushed.	Press the  button once to power-up the UPS and connected equipment.
The UPS is not connected to utility power supply.	Check that the power cord from the UPS to the utility power supply is securely connected at both ends.
Very low or no utility voltage	Check the utility power supply to the UPS by plugging in a table lamp. If the light is very dim, have the utility voltage checked.
UPS will not turn off	
The UPS has detected an internal fault.	Do not attempt to use the UPS. Unplug the UPS and have it serviced immediately.
UPS beeps occasionally	
Normal UPS operation when running on battery.	None: The UPS is protecting the connected equipment. Press the  button to silence this audible alarm.
UPS is not providing expected backup time	
The UPS battery(s) are weak due to a recent power outage or battery(s) are near the end of their service life.	Charge the battery(s). Batteries require recharging after extended outages. Batteries can wear faster when put into service often or when operated at elevated temperatures. If the battery(s) are near the end of their service life, consider replacing the battery(s) even if the <i>replace battery</i> LED is not yet illuminated.
All LEDs are illuminated and the UPS emits a constant beeping	
The UPS has detected an internal fault.	Do not attempt to use the UPS. Unplug the UPS and have it serviced immediately.
Front panel LEDs flash sequentially	
The UPS has been shut down remotely through software or an optional accessory card.	None: The UPS will restart automatically when utility power returns.
All LEDs are off and the UPS is plugged into a wall outlet	
The UPS is shut down or the battery is discharged from an extended outage.	None: The UPS will restart automatically when utility power is restored and the battery has a sufficient charge.

Problem and/or Possible Cause	Solution
The Overload LED is illuminated and the UPS emits a sustained audible alarm tone	
The UPS is overloaded.	<p>The connected equipment exceeds the specified “maximum load” as defined in Specifications on the APC by Schneider Electric Web site, www.apc.com.</p> <p>The audible alarm remains on until the overload is removed. Disconnect nonessential equipment from the UPS to eliminate the overload condition.</p> <p>The UPS continues to supply power as long as it is online and the circuit breaker does not trip; the UPS will not provide power from batteries in the event of a utility voltage interruption.</p>
The Replace Battery/Battery Disconnected LED is illuminated	
The <i>Replace Battery/Battery Disconnected</i> LED flashes and a short beep is emitted every two seconds to indicate the battery is disconnected.	Check that the battery connectors are fully engaged.
Weak battery	Allow the battery to recharge for 24 hours and perform a self-test. If the problem persists after recharging, replace the battery.
When a battery self-test does not pass, <i>Replace Battery/Battery Disconnected</i> LED illuminates and the UPS emits short beeps for one minute. The UPS repeats the audible alarm every five hours.	<p>Allow the battery to recharge for 24 hours. Perform the self-test procedure to confirm the replace battery condition. The audible alarm stops and the LED clears if the battery passes the self-test.</p> <p>If the battery test does not pass again, it must be replaced. The connected equipment is unaffected.</p>
The input circuit breaker trips	
The connected equipment exceeds the specified “maximum load” as defined in <i>Specifications</i> on the APC by Schneider Electric Web site, www.apc.com .	<p>Unplug all nonessential equipment from the UPS.</p> <p>Reset the circuit breaker.</p>
The AVR Boost or AVR Trim LEDs are illuminated	
The system is experiencing very high or low utility voltage.	Have a qualified service personnel check your facility for electrical problems. If the problem persists, contact the utility company for further assistance.

Problem and/or Possible Cause	Solution
There is no utility power	
There is no utility power and the UPS is off.	<p>Use the cold start feature to supply battery power to the connected equipment.</p> <p>Press and hold the  button. There will be a short beep followed by a longer beep. Release the button during the second beep.</p>
UPS operates on battery although line voltage exists	
The UPS input circuit breaker trips.	<p>Unplug all nonessential equipment from the UPS.</p> <p>Reset the circuit breaker.</p>
Your system is experiencing very high, low or distorted line voltage.	<p>Move the UPS to a different outlet on a different circuit: Inexpensive fuel powered generators may distort the voltage. Test the input voltage with the utility voltage display, (see <i>Operation</i>). If acceptable to the connected equipment, reduce the UPS sensitivity.</p>
Battery Charge and Load LEDs flash simultaneously	
<p>The UPS has shut down.</p> <p>The internal temperature of the UPS has exceeded the allowable threshold for operation.</p>	<p>Check that the room temperature is within the specified limits for operation.</p> <p>Check that the UPS is properly installed, allowing for adequate ventilation.</p> <p>Allow the UPS to cool down. Restart the UPS. If the problem persists, contact APC by Schneider Electric at www.apc.com.</p>
Diagnostic utility voltage	
All five LEDs are illuminated.	The line voltage is extremely high and should be checked by an electrician.
There is no LED illumination.	The line voltage is extremely low and should be checked by an electrician.
On Line LED	
There is no LED illumination.	The UPS is running on battery, or it must be turned on.
The LED is blinking.	The UPS is running an internal self-test.

Service

If the unit requires service, do not return it to the dealer. Follow these steps:

1. Review the Troubleshooting section of the manual to eliminate common problems.
2. If the problem persists, contact APC by Schneider Electric Customer Support.
 - a. Note the model number and serial number and the date of purchase. The model and serial numbers are located on the rear panel of the unit and are available through the LCD display on select models.
 - b. Call APC by Schneider Electric Customer Support and a technician will attempt to solve the problem over the phone. If this is not possible, the technician will issue a Service Request Number.
 - c. If the unit is under warranty, the repairs are free.

An Authorized Service Representative will visit your location and try to resolve the issue.

Two-Year Factory Warranty

Schneider Electric IT Business India Private Ltd. (SEITBIPL), warrants its products to be free from defects in materials and workmanship for a period of two (2) years from the date of purchase. The SEITBIPL obligation under this warranty is limited to repairing or replacing, at its own sole option, any such defective products or parts there of. Repair or replacement of a defective product or part thereof does not extend the original warranty period.

This warranty applies only to the original purchaser who must have properly registered the product within 10 days of purchase. Products may be registered online at warranty.apc.com or by mailing in the completed warranty registration card that is included with the documentation.

SEITBIPL shall not be liable under the warranty if its testing and examination disclose that the alleged defect in the product does not exist or was caused by end user's or any third person's misuse, negligence, improper installation, testing, operation or use of the product contrary to SEITBIPL's recommendations or specifications. Further, SEITBIPL shall not be liable for defects resulting from: 1) unauthorized attempts to repair or modify the product, 2) incorrect or inadequate electrical voltage or connection, 3) inappropriate on site operation conditions, 4) Acts of God, 5) exposure to the elements, 6) theft. In no event shall SEITBIPL have any liability under this warranty for any product where the serial number has been altered, defaced, or removed, 7) normal wear resulting from frequent use.

EXCEPT AS SET FORTH ABOVE, THERE ARE NO WARRANTIES, EXPRESS OR IMPLIED, BY OPERATION OF LAW OR OTHERWISE, APPLICABLE TO PRODUCTS SOLD, SERVICED OR FURNISHED UNDER THIS AGREEMENT OR IN CONNECTION HEREWITH.

SEITBIPL DISCLAIMS ALL IMPLIED WARRANTIES OF MERCHANTABILITY, SATISFACTION AND FITNESS FOR A PARTICULAR PURPOSE.

SEITBIPL EXPRESS WARRANTIES WILL NOT BE ENLARGED, DIMINISHED, OR AFFECTED BY AND NO OBLIGATION OR LIABILITY WILL ARISE OUT OF, SEITBIPL'S RENDERING OF TECHNICAL OR OTHER ADVICE OR SERVICE IN CONNECTION WITH THE PRODUCTS.

THE FOREGOING WARRANTIES AND REMEDIES ARE EXCLUSIVE AND IN LIEU OF ALL OTHER WARRANTIES AND REMEDIES. THE WARRANTIES SET FORTH ABOVE CONSTITUTE SEITBIPL'S SOLE LIABILITY AND PURCHASER'S EXCLUSIVE REMEDY FOR ANY BREACH OF SUCH WARRANTIES. SEITBIPL WARRANTIES EXTEND ONLY TO ORIGINAL PURCHASER AND ARE NOT EXTENDED TO ANY THIRD PARTIES.

IN NO EVENT SHALL SEITBIPL, ITS OFFICERS, DIRECTORS, AFFILIATES OR EMPLOYEES BE LIABLE FOR ANY FORM OF INDIRECT, SPECIAL, CONSEQUENTIAL OR PUNITIVE DAMAGES, ARISING OUT OF THE USE, SERVICE OR INSTALLATION OF THE PRODUCTS, WHETHER SUCH DAMAGES ARISE IN CONTRACT OR TORT, IRRESPECTIVE OF FAULT, NEGLIGENCE OR STRICT LIABILITY OR WHETHER SEITBIPL HAS BEEN ADVISED IN ADVANCE OF THE POSSIBILITY OF SUCH DAMAGES. SPECIFICALLY, SEITBIPL IS NOT LIABLE FOR ANY COSTS, SUCH AS LOST PROFITS OR REVENUE, WHETHER DIRECT OR INDIRECT, LOSS OF EQUIPMENT, LOSS OF USE OF EQUIPMENT, LOSS OF SOFTWARE, LOSS OF DATA, COSTS OF SUBSTITUANTS, CLAIMS BY THIRD PARTIES, OR OTHERWISE.

To obtain service under warranty you must call customer support. Customers with warranty claims issues may access the SEITBIPL worldwide customer support network through the SEITBIPL Web site: support.apc.com. Select your country from the country selection drop down menu. Open the Support tab at the top of the web page to obtain information for customer support in your region. Refer to the product user manual for more information on how to contact customer support.

APC by Schneider Electric Customer Support India

Internet <http://www.apc.com/support>

Toll Free 1 800 425 4272

E-mail indiainfo@apc.com

© 2015 APC by Schneider Electric. APC, the APC logo, and Smart-UPS are owned by Schneider Electric Industries S.A.S. or their affiliated companies. All other trademarks are property of their respective owners.