

A B C D E F G H

REVISIONS					
REV.	SUFFIX	ECO #	DESCRIPTION	DATE	APPROVED
01			RELEASE TO PRODUCTION	16 JUL 14	K SCHALLER
02			REVISED SECTION LETTERING, REV SOME TEXT	23 JUL 14	K SCHALLER
03			1) DEHUMIDIFIER WAS RELOCATED; 2) H2O PIPING TO IN ROW WAS 1" & ADDED INSTR TAPS; 3) HUMIDISTAT WAS IN LOBBY; 4) PIPED IN ROW DRAINS OUT; 5) SHOWED NOZZLES ON FIRE SUP.	18 AUG 14	K SCHALLER

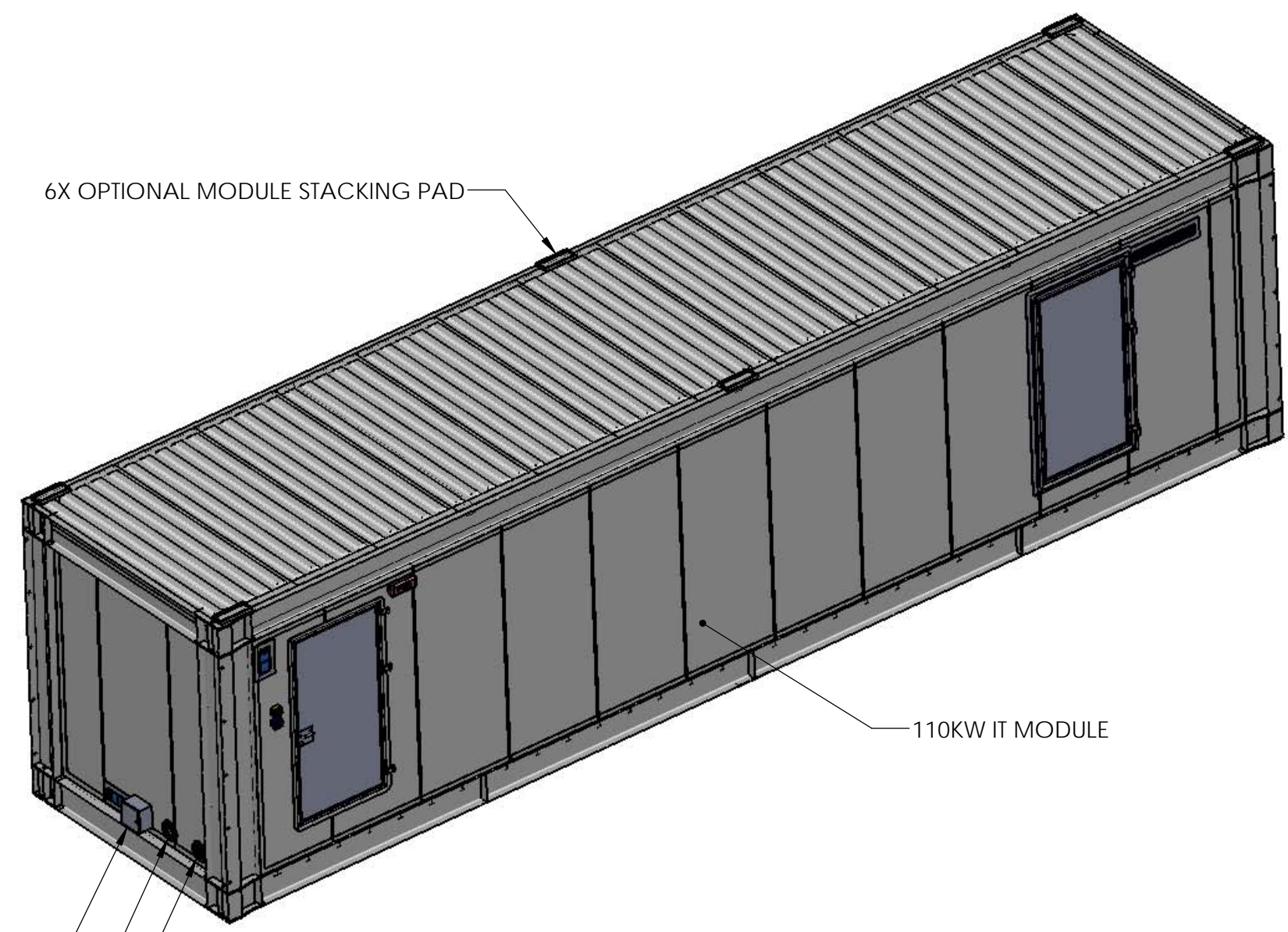

- 4 INCH CHILLED WATER RETURN (1 ON EACH END FOR TIER 3) 2
- 4 INCH CHILLED WATER SUPPLY (1 ON EACH END FOR TIER 3) 2
- CUSTOMER GROUND CONNECTION PANEL

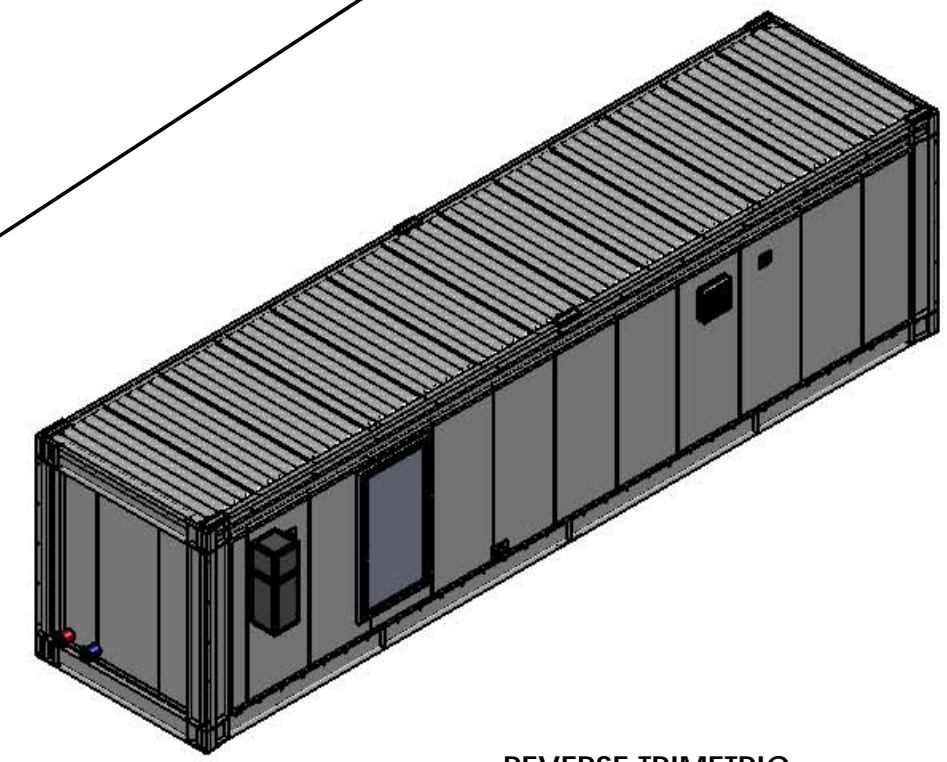

NOTES, UNLESS OTHERWISE SPECIFIED:
 1. ALL DIMENSIONS ARE IN MILLIMETERS (INCHES).
 2. ALL DATA CABLE, POWER CABLE, AND COOLING PIPING INTERFACES ARE THROUGH ROXTEC CABLE ENTRY SEALS.

THIS DRAWING AND SPECIFICATIONS HEREIN ARE THE PROPERTY OF SCHNEIDER ELECTRIC AND SHALL NOT BE COPIED, REPRODUCED OR USED IN WHOLE OR IN PART, AS THE BASIS FOR THE MANUFACTURE OR SALE OF ITEMS WITHOUT WRITTEN PERMISSION FROM SCHNEIDER ELECTRIC. THIS DRAWING IS BASED UPON LATEST AVAILABLE INFORMATION AND IS SUBJECT TO CHANGE WITHOUT NOTICE.



TITLE: 110kW PRE-FABRICATED IT MODULE, PDU, EMEA
 PROJECT: PRE-FAB SOLUTIONS

DWG NO. PFMIEA110C1E13B
 ENGINEER: M UHRHAN 5/13/2014
 DRAWN: K SCHALLER 5/13/2014
 APPROVED: M UHRHAN 5/13/2014

REV 03
 SIZE B

A B C D E F G H

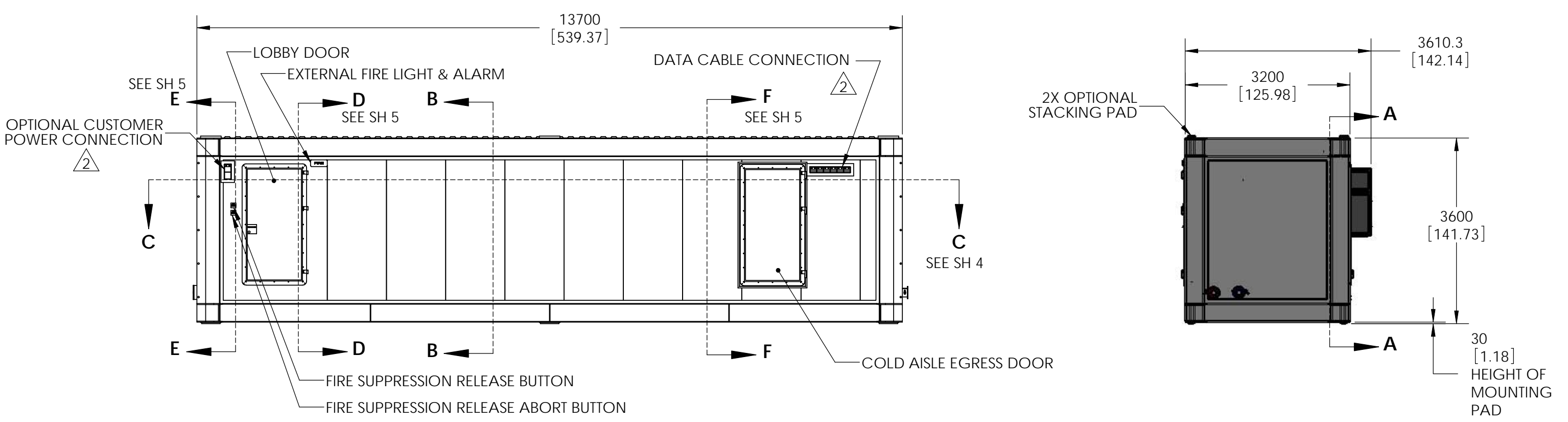
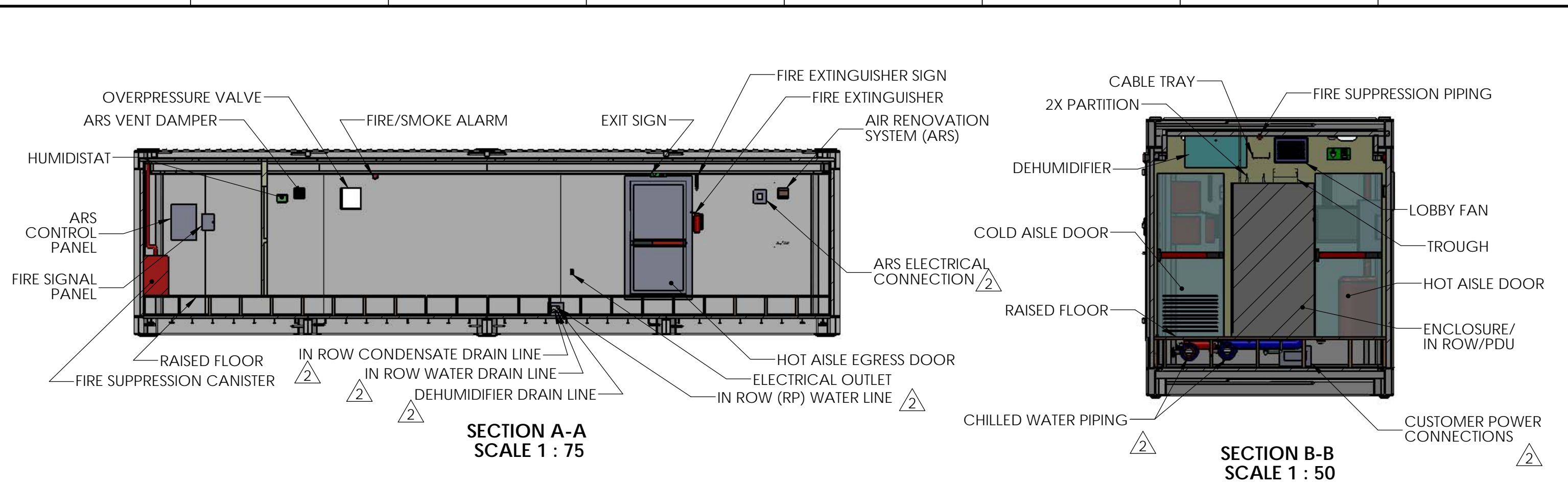

THIS DRAWING AND SPECIFICATIONS HEREIN ARE THE PROPERTY OF SCHNEIDER ELECTRIC AND SHALL NOT BE COPIED, REPRODUCED OR USED IN WHOLE OR IN PART, AS THE BASIS FOR THE MANUFACTURE OR SALE OF ITEMS WITHOUT WRITTEN PERMISSION FROM SCHNEIDER ELECTRIC. THIS DRAWING IS BASED UPON LATEST AVAILABLE INFORMATION AND IS SUBJECT TO CHANGE WITHOUT NOTICE.		TITLE:	110kW PRE-FABRICATED IT MODULE, PDU, EMEA		DWG NO.:	PFMIEA110C1E13B	REV	03	
		PROJECT:	PRE-FAB SOLUTIONS	SHEET 2 OF 6	ENGINEER:	M UHRHAN	5/13/2014	SIZE	B
					DRAWN:	K SCHALLER	5/13/2014		
					APPROVED:	M UHRHAN	5/13/2014		

A B C D E F G H

A B C D E F G H

1

1

2

2

3

3

4

4

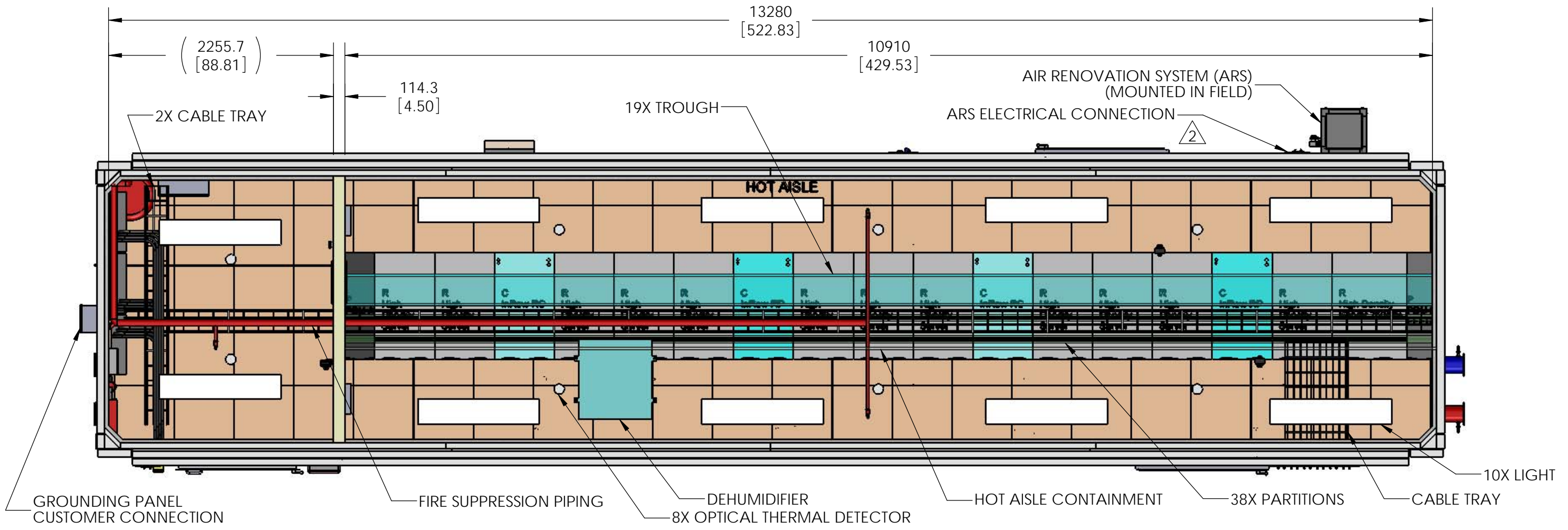

TOP VIEW
 ROOF & OUTER FRAME NOT SHOWN
 SCALE 1 : 40

THIS DRAWING AND SPECIFICATIONS HEREIN ARE THE PROPERTY OF SCHNEIDER ELECTRIC AND SHALL NOT BE COPIED, REPRODUCED OR USED IN WHOLE OR IN PART, AS THE BASIS FOR THE MANUFACTURE OR SALE OF ITEMS WITHOUT WRITTEN PERMISSION FROM SCHNEIDER ELECTRIC. THIS DRAWING IS BASED UPON LATEST AVAILABLE INFORMATION AND IS SUBJECT TO CHANGE WITHOUT NOTICE.

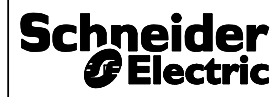

TITLE: 110kW PRE-FABRICATED IT MODULE, PDU, EMEA
 PROJECT: PRE-FAB SOLUTIONS

DWG NO.	PFMIEA110C1E13B		REV	03
ENGINEER:	M UHRHAN	5/13/2014	SIZE	B
DRAWN:	K SCHALLER	5/13/2014		
APPROVED:	M UHRHAN	5/13/2014		

A B C D E F G H

A B C D E F G H

1

1

2

2

3

3

4

4

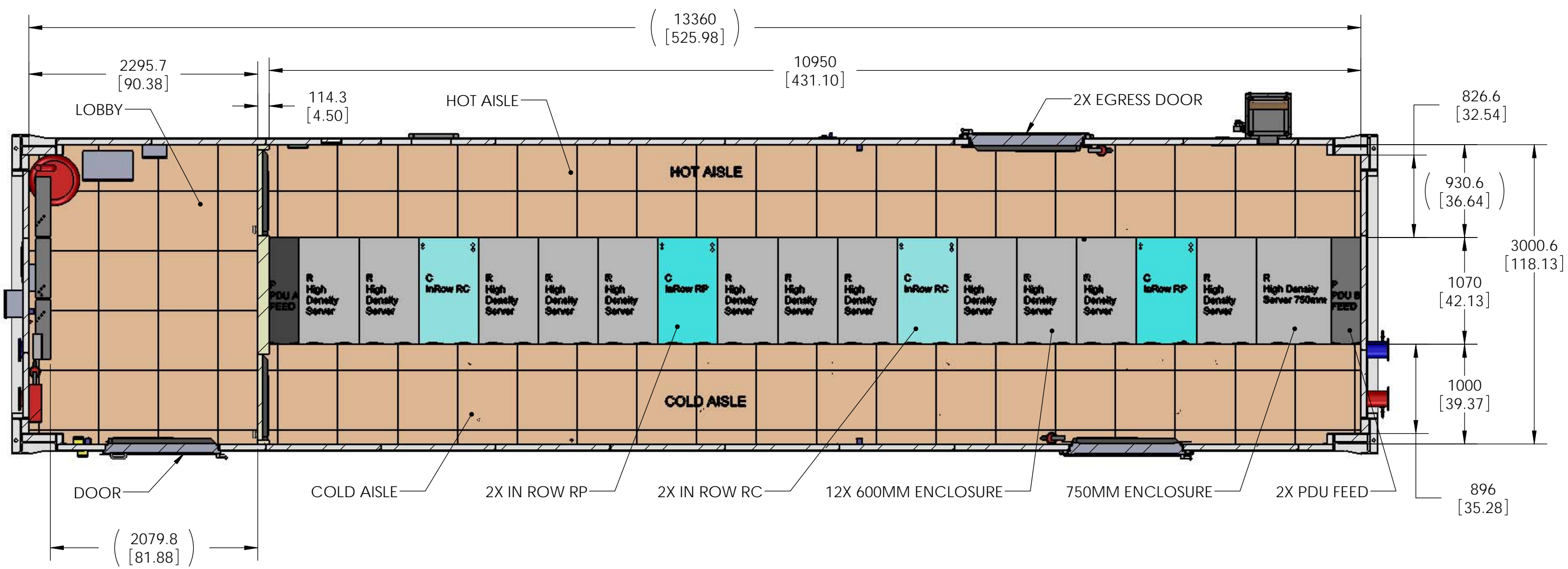

SECTION C-C
SCALE 1 : 40
 SEE SHEET 2; ZONE E3

THIS DRAWING AND SPECIFICATIONS HEREIN ARE THE PROPERTY OF SCHNEIDER ELECTRIC AND SHALL NOT BE COPIED, REPRODUCED OR USED IN WHOLE OR IN PART, AS THE BASIS FOR THE MANUFACTURE OR SALE OF ITEMS WITHOUT WRITTEN PERMISSION FROM SCHNEIDER ELECTRIC. THIS DRAWING IS BASED UPON LATEST AVAILABLE INFORMATION AND IS SUBJECT TO CHANGE WITHOUT NOTICE.

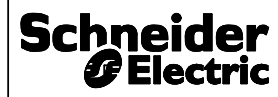

TITLE: 110kW PRE-FABRICATED IT MODULE, PDU, EMEA
 PROJECT: PRE-FAB SOLUTIONS SHEET 4 OF 6

DWG NO.	PFMIEA110C1E13B		REV	03
ENGINEER:	M UHRHAN	5/13/2014	SIZE	B
DRAWN:	K SCHALLER	5/13/2014		
APPROVED:	M UHRHAN	5/13/2014		

A B C D E F G H

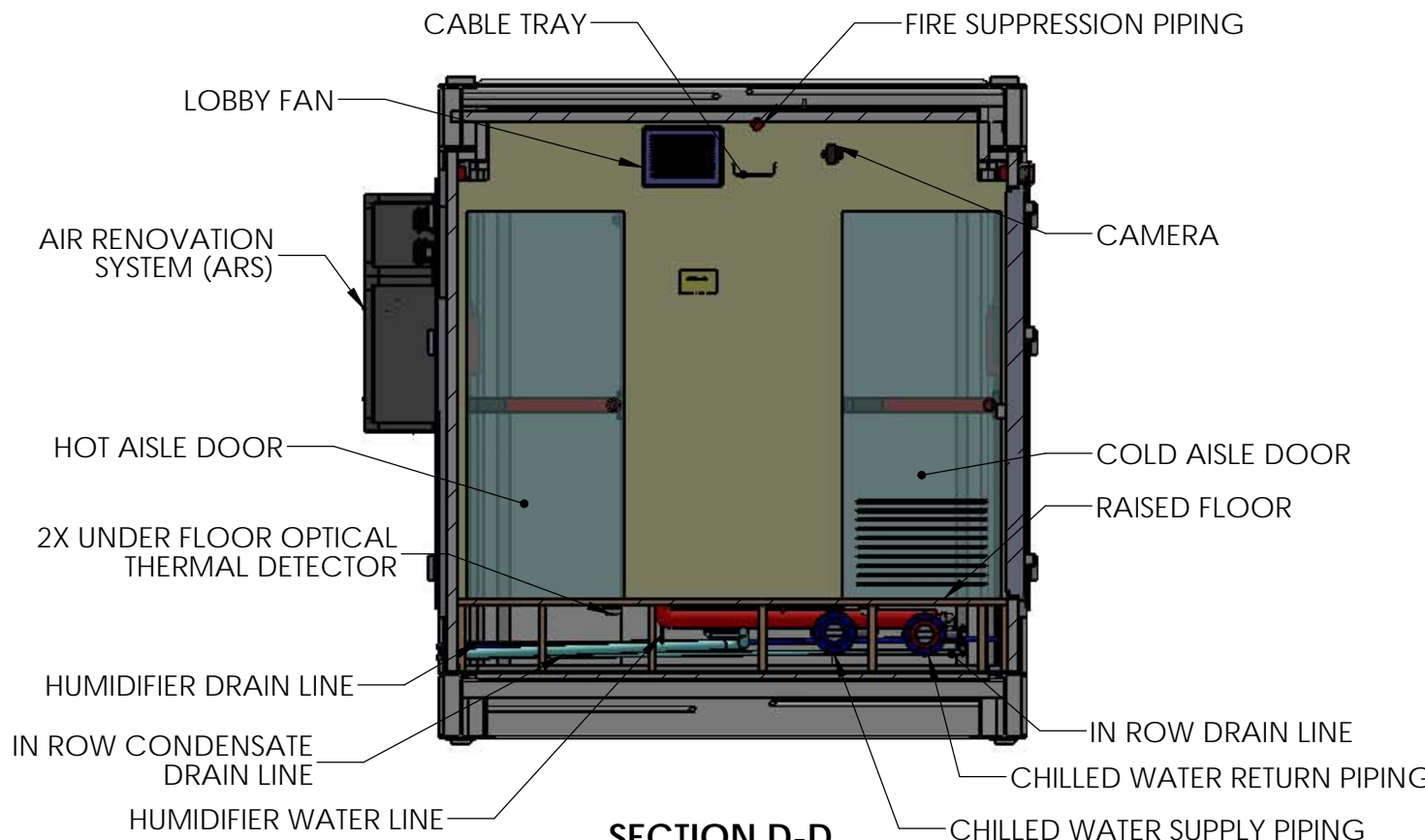

SECTION D-D
SCALE 1 : 40
SEE SHEET 2; ZONE B3

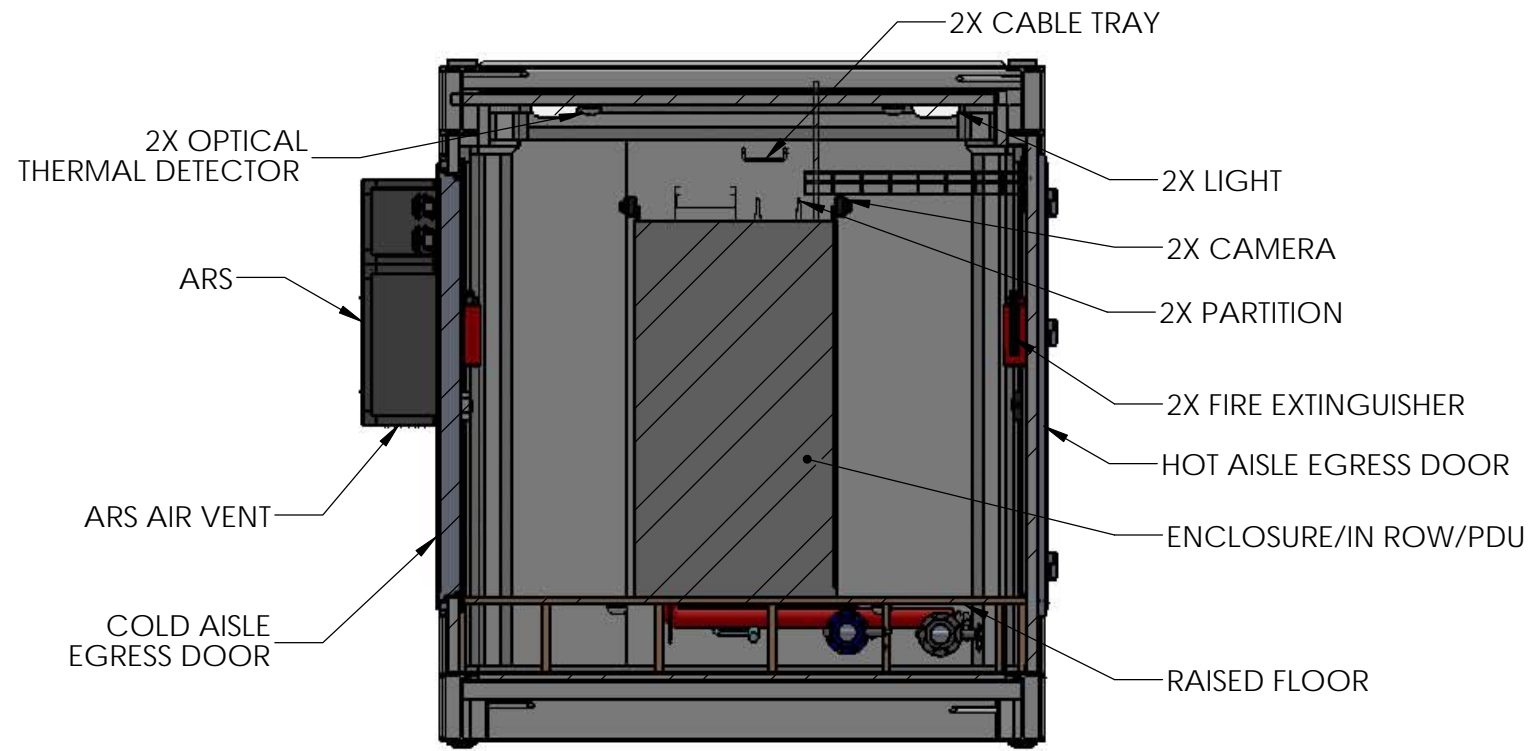

SECTION F-F
SCALE 1 : 40
SEE SHEET 2; ZONE D3

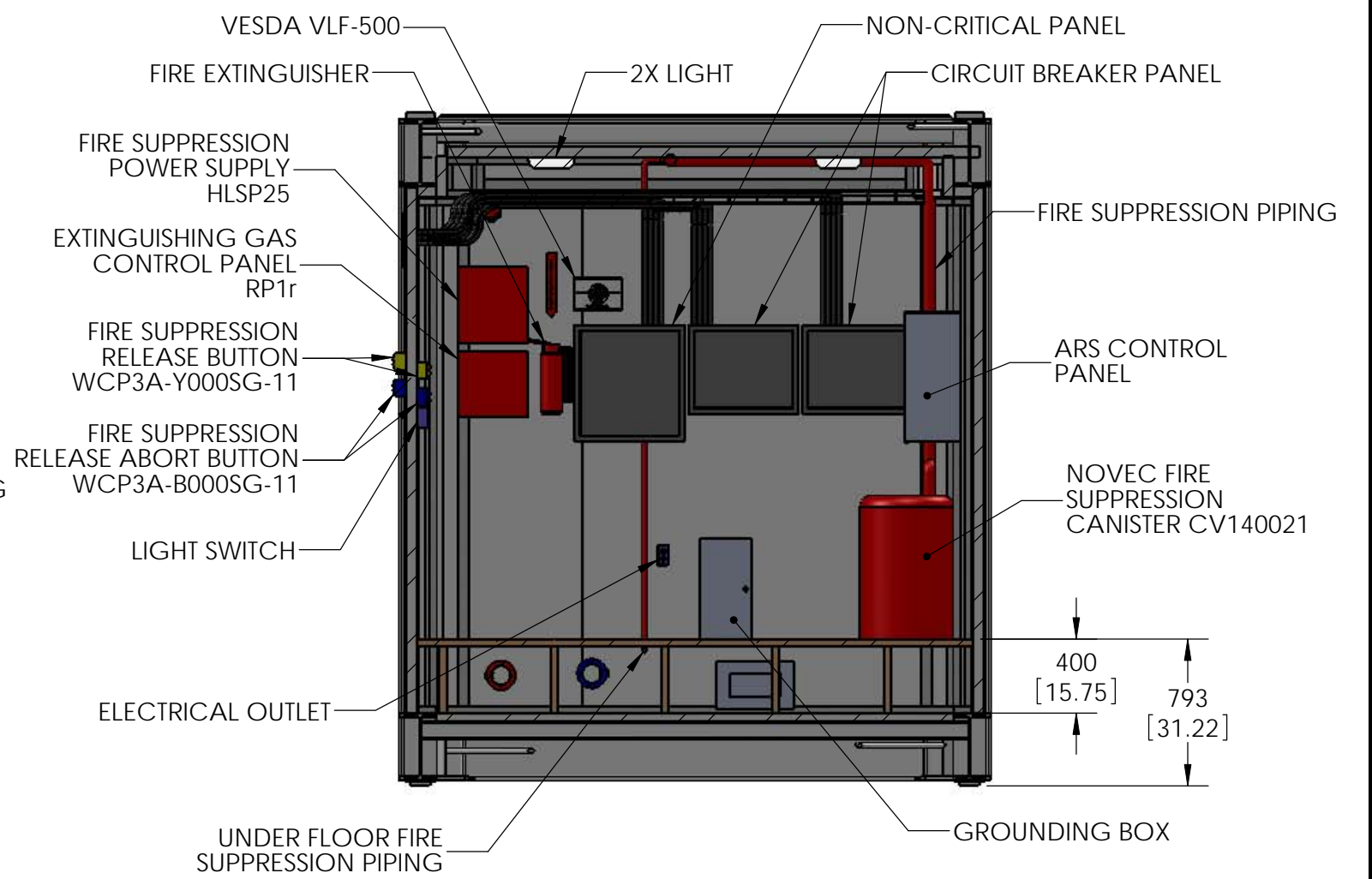

SECTION E-E
SCALE 1 : 35
SEE SHEET 2; ZONE B3

THIS DRAWING AND SPECIFICATIONS HEREIN ARE THE PROPERTY OF SCHNEIDER ELECTRIC AND SHALL NOT BE COPIED, REPRODUCED OR USED IN WHOLE OR IN PART, AS THE BASIS FOR THE MANUFACTURE OR SALE OF ITEMS WITHOUT WRITTEN PERMISSION FROM SCHNEIDER ELECTRIC. THIS DRAWING IS BASED UPON LATEST AVAILABLE INFORMATION AND IS SUBJECT TO CHANGE WITHOUT NOTICE.

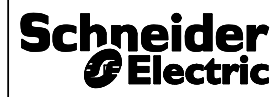

TITLE: 110kW PRE-FABRICATED IT MODULE, PDU, EMEA
PROJECT: PRE-FAB SOLUTIONS SHEET 5 OF 6

DWG NO.	PFMIEA110C1E13B		REV	03
ENGINEER:	M UHRHAN	5/13/2014	SIZE	B
DRAWN:	K SCHALLER	5/13/2014		
APPROVED:	M UHRHAN	5/13/2014		

A B C D E F G H

1

1

2

2

3

3

4

4

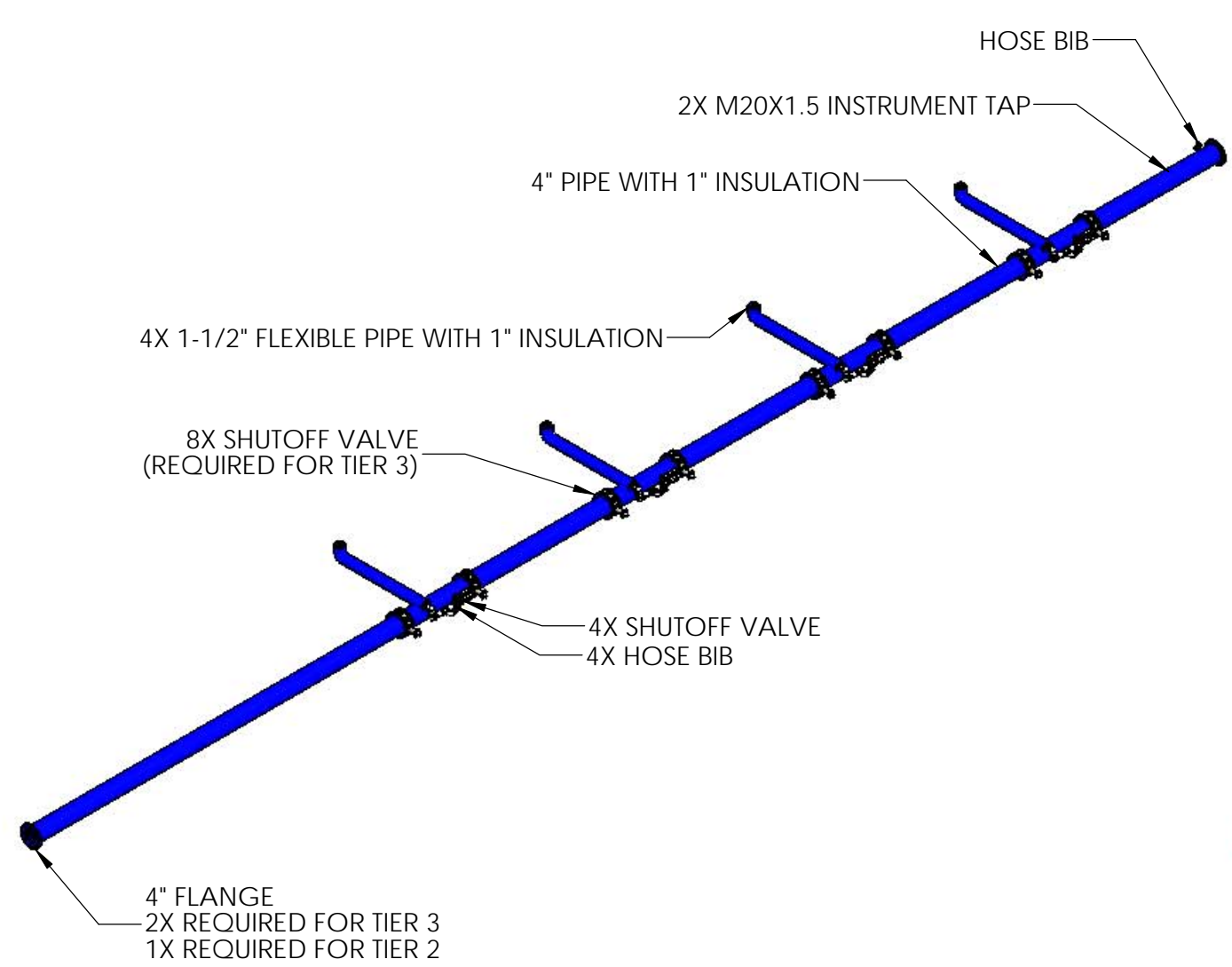

CHILLED WATER SUPPLY PIPING
TIER 3 OPTION SHOWN

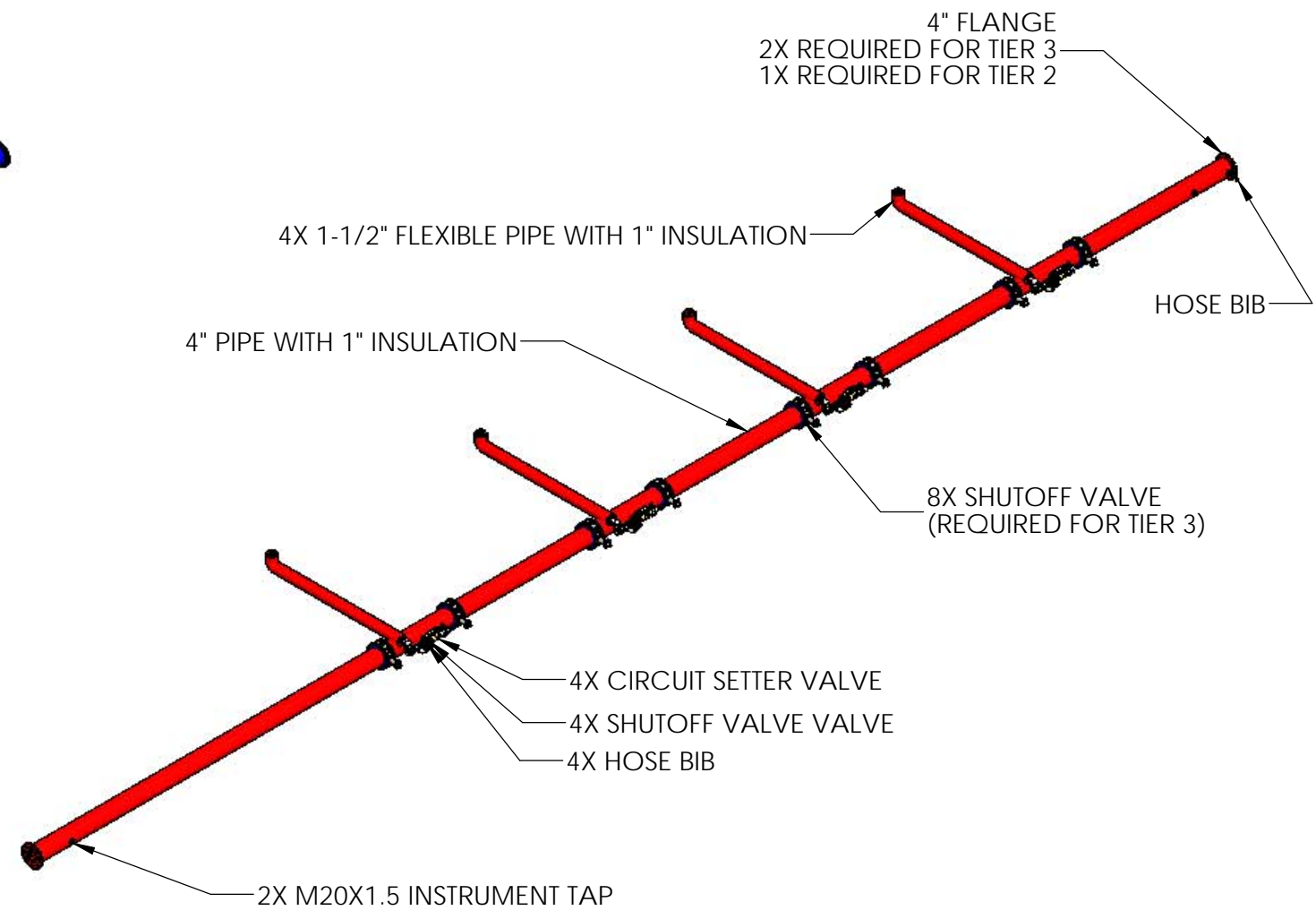

CHILLED WATER RETURN PIPING
TIER 3 OPTION SHOWN

THIS DRAWING AND SPECIFICATIONS HEREIN ARE THE PROPERTY OF SCHNEIDER ELECTRIC AND SHALL NOT BE COPIED, REPRODUCED OR USED IN WHOLE OR IN PART, AS THE BASIS FOR THE MANUFACTURE OR SALE OF ITEMS WITHOUT WRITTEN PERMISSION FROM SCHNEIDER ELECTRIC. THIS DRAWING IS BASED UPON LATEST AVAILABLE INFORMATION AND IS SUBJECT TO CHANGE WITHOUT NOTICE.



TITLE: 110KW PRE-FABRICATED IT MODULE, PDU, EMEA
PROJECT: PRE-FAB SOLUTIONS

DWG NO.	PFMIEA110C1E13B		REV	03
ENGINEER:	M UHRHAN	5/13/2014	SIZE	B
DRAWN:	K SCHALLER	5/13/2014		
APPROVED:	M UHRHAN	5/13/2014		

A B C D E F G H