

# Operation Manual

## Smart-UPS<sup>™</sup> C Uninterruptible Power Supply

Tower

1000/1500 VA

120/230 Vac

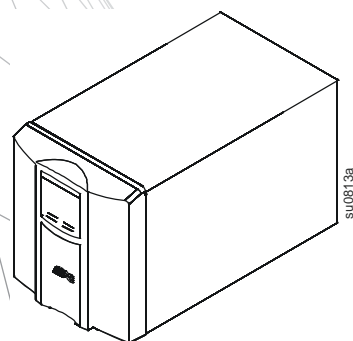

# Product Description

---

The APC™ by Schneider Electric Smart-UPS™ is a high performance uninterruptible power supply (UPS). The UPS provides protection for electronic equipment from utility power blackouts, brownouts, sags, and surges, small utility power fluctuations and large disturbances. The UPS also provides battery backup power for connected equipment until utility power returns to safe levels or the batteries are fully discharged.

This user manual is available on the enclosed Documentation CD and on the APC by Schneider Electric Web site, [www.apc.com](http://www.apc.com).

## Important Safety Messages

---

Read the instructions carefully to become familiar with the equipment before trying to install, operate, service or maintain it. The following special messages may appear throughout this manual or on the equipment to warn of potential hazards or to call attention to information that clarifies or simplifies a procedure.



The addition of this symbol to a Caution product safety label indicates that a hazard exists that can result in injury and product damage if the instructions are not followed.

The following safety messages may appear throughout this manual to warn of potential hazards.

<b>CAUTION</b>
----------------

<b>CAUTION</b> indicates a potentially hazardous situation which, if not avoided, <b>can result in</b> equipment damage.
--

## Safety and General Information

**Inspect the package contents upon receipt. Notify the carrier and dealer if there is any damage.**

**Read the Safety Guide supplied with this unit before installing the UPS.**

- Adhere to all local and national electrical codes.
- This UPS is intended for indoor use only.
- Do not operate this UPS in direct sunlight, in contact with fluids, or where there is excessive dust or humidity.
- Be sure the air vents on the UPS are not blocked. Allow adequate space for proper ventilation.
- The battery typically lasts for two to five years. Environmental factors impact battery life. Elevated ambient temperatures, poor quality utility power, and frequent short duration discharges will shorten battery life.
- Connect the UPS power cable directly to a wall outlet. Do not use surge protectors or extension cords.
- The batteries are heavy. Remove the batteries prior to installing the UPS in a rack.
- Refer to “Specifications” on page 2 for UPS and battery weight.

# Specifications

For additional specifications, refer to the APC by Schneider Electric Web site at [www.apc.com](http://www.apc.com).

	UPS + Battery	Battery
<b>Weight specifications</b>	SMC1000 / SMC1000I 17.24 kg (38 lb)	APCRBC142 5.1 kg (11.2 lb)
	SMC1500 / SMC1500I 20.41 kg (45 lb)	APCRBC6 7.7 kg (16.9 lb)
<b>Temperature</b>	<b>Operating</b>	0° to 40° C (32° to 104° F)
	<b>Storage</b>	-15° to 45° C (5° to 113° F) charge UPS battery every six months
<b>Maximum Elevation</b>	<b>Operating</b>	3,000 m (10,000 ft)
	<b>Storage</b>	15,000 m (50,000 ft)
<b>Humidity</b>	0% to 95% relative humidity, non-condensing	0° to 40° C (32° to 104° F)
<b>Battery Type</b>	Maintenance free, sealed lead acid	

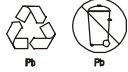

Replace used batteries with APC by Schneider Electric approved batteries.  
To order a replacement battery go to the APC by Schneider Electric Web site, [www.apc.com](http://www.apc.com).  
**Always recycle used batteries.**  
**For information on recycling a used battery, refer to the Battery Disposal Information sheet included with the replacement battery.**

# Product Overview

## Front panel features

- ❶ Display interface
- ❷ Bezel
- ❸ Battery
- ❹ Internal battery connector cables

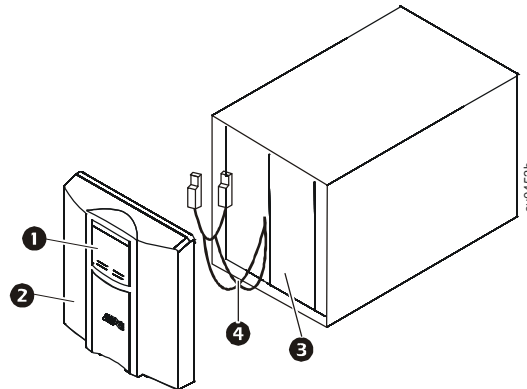

## Rear panel features

- ❶ USB Port
- ❷ Serial data port
- ❸ Battery connector
- ❹ Circuit breaker
- ❺ UPS input
- ❻ Outlets
- ❼ Chassis ground screw

120 Vac

230 Vac

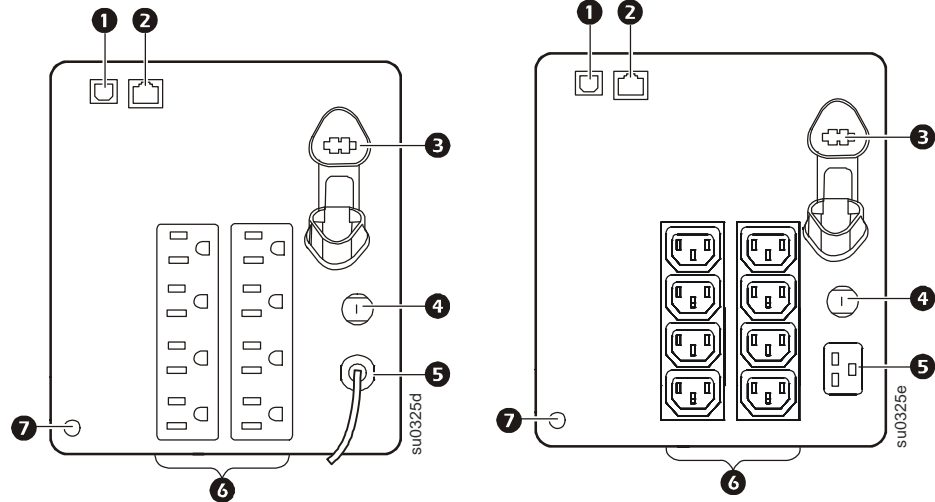

## Installation

For UPS installation information, refer to the Installation Guide for the Smart-UPS C 1000/1500 VA Tower included with the UPS.

The Installation Guide is also available on the Documentation CD included with the UPS and on the APC by Schneider Electric Web site, [www.apc.com](http://www.apc.com).

# Operation



**Note:** The UPS will charge to 90% capacity in the first three hours of normal operation.  
**Do not expect full battery runtime capability during this initial charge period.**

1. Connect equipment to the UPS.
2. Connect the UPS to a two pole, three wire, grounded source.

## CAUTION

### RISK OF EQUIPMENT DAMAGE

- Adhere to all local and national electrical codes.
- Wiring should be performed by qualified electrician.
- Always connect the UPS to a grounded outlet.

**Failure to follow these instructions can result in equipment damage**

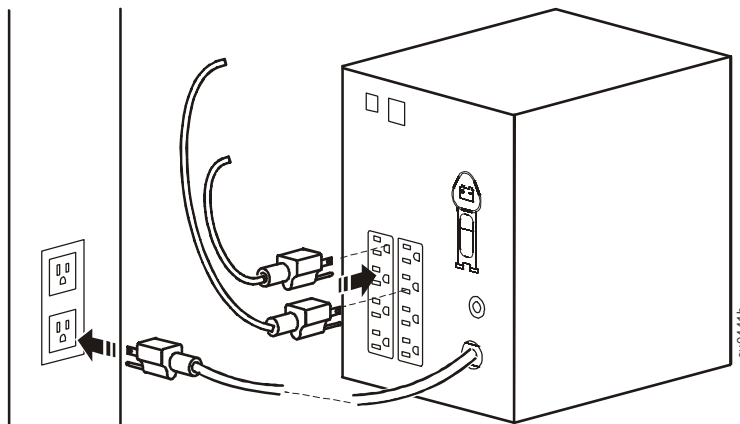

## Connect equipment to the UPS



**USB port:** Connect to a computer to use power management software.



**Serial port:** Connect a serial port cable (not supplied) to use power management software.



**Chassis ground screw:** Connect the ground leads on transient voltage devices to the chassis ground screw(s), located on the rear panel of the UPS.





## Configuration mode

Configuration mode provides additional UPS configuration options. Press and hold the MUTE and MENU buttons  for two seconds. The UPS will emit a short beep and the two icons will flash to indicate that Configuration mode is enabled.

When Configuration mode is enabled use the MENU button to scroll through the available options. Use the MUTE button to scroll through the settings in each option.



**Note:** The UPS will automatically disable Configuration mode after 15 seconds of no activity. To manually disable Configuration mode, press and hold the MUTE and MENU buttons for two seconds. The UPS will emit a short beep.

Function	Options	Description
<b>Self-Test</b>	<ul style="list-style-type: none"> <li>• 0: Default Setting</li> <li>• 1: Begin Self-Test</li> </ul>	<p>0 is the default setting for Configuration mode. Press the MENU button to scroll through the available options.</p> <p>Press 1 to manually initiate a Self-Test. The UPS will automatically disable Configuration mode.</p> <p><b>Note:</b> When the UPS is operating on battery power and Configuration mode is enabled, only the default setting will be available. A manual Self-Test cannot be initiated.</p>
<b>Power Quality</b>	<ul style="list-style-type: none"> <li>• Good </li> <li>• Fair </li> <li>• Poor </li> </ul>	<p>Select the input utility power quality tolerance.</p> <ul style="list-style-type: none"> <li>• When Good is selected, the unit will go on battery power more often to provide the cleanest power supply to the connected equipment.</li> <li>• When Fair is selected, the UPS is under normal operating conditions.</li> <li>• When Poor is selected, the UPS will tolerate more fluctuations in power and will go on battery power less often.</li> </ul> <p>If unsure of the local power quality, select Good.</p>
<b>Output Voltage Setting</b> 230V models only	<ul style="list-style-type: none"> <li>• 220 Vac</li> <li>• 230 Vac</li> <li>• 240 Vac</li> </ul>	Select the appropriate voltage for outlets when the UPS is in battery mode.
<b>LCD Display Dimmer</b>	<ul style="list-style-type: none"> <li>• Load Bar Icon shows 100% = Always On. </li> <li>• Load Bar Icon shows 0% = Auto Dim. </li> </ul>	When the LCD display dimmer is configured to Auto Dim the LCD will illuminate if a button is pressed or an event occurs. The display will automatically dim after 60 seconds of no activity.
<b>Green Mode Enable</b>	<ul style="list-style-type: none"> <li>• 0: Disable</li> <li>• 1: Enable</li> </ul>	When Green Mode is enabled the UPS is operating at the most efficient level, bypassing unused AVR components while acceptable utility voltage is present. The UPS will enter and exit Green mode automatically while enabled.
<b>Clear Event Counter</b>	N/A	Press the MUTE button to clear the event counter.

## Power saving LCD screen

The display interface can be configured to remain continuously illuminated or to extinguish after a period of inactivity to save electricity.

1. **Continuous Illumination Mode:** Press and hold the DISPLAY button for two seconds. The display will illuminate and the UPS will beep to confirm **Continuous Illumination** mode is activated.
2. **Power Saving mode:** Press and hold the DISPLAY button for two seconds. The display will extinguish and the UPS will beep to confirm **Power Saving** mode is enabled. While in **Power Saving** mode, the display will illuminate when a button is pressed. The display will extinguish after 60 seconds of inactivity.

## Sensitivity adjustment settings

The UPS detects and reacts to line voltage distortions by transferring to battery backup power to protect connected equipment. In situations where either the UPS or the connected equipment is too sensitive for the input voltage level it is necessary to adjust the transfer voltage.

1. Connect the UPS to a utility power source. Be sure the UPS is turned off.
2. Press and hold the POWER button for six seconds. The **load capacity** bar will flash on and off, to indicate the UPS is in **Program** mode.
3. Press the POWER button again to scroll through the menu options. The UPS will beep to confirm the selection.

When the UPS is in **Sensitivity Configuration** mode, the **Sensitivity** bar graph icons display the sensitivity level setting. See the examples here as a reference.

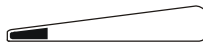

Low sensitivity

1000/1500 VA 120 Vac: 97-136 Vac  
1000/1500 VA 230 Vac: 195-265 Vac

Use this setting with equipment that is less sensitive to fluctuations in voltage or waveform distortions.



Medium sensitivity

1000/1500 VA 120 Vac: 103-130 Vac  
1000/1500 VA 230 Vac: 203-257 Vac

Use this setting under normal operating conditions.



High sensitivity (Default)

1000/1500 VA 120 Vac: 106-127 Vac  
1000/1500 VA 230 Vac: 207-253 Vac

Use this setting when connected equipment is sensitive to any minor fluctuations in voltage or waveform distortions.

# Status Indicators

## Display panel features

1000/1500 VA 120 Vac

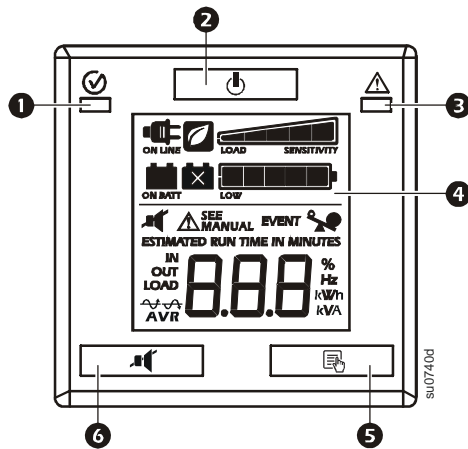

- ❶ On Line/On Battery LED
- ❷ POWER ON/OFF button
- ❸ Site Wiring Fault/System Fault LED

1000/1500 VA 230 Vac

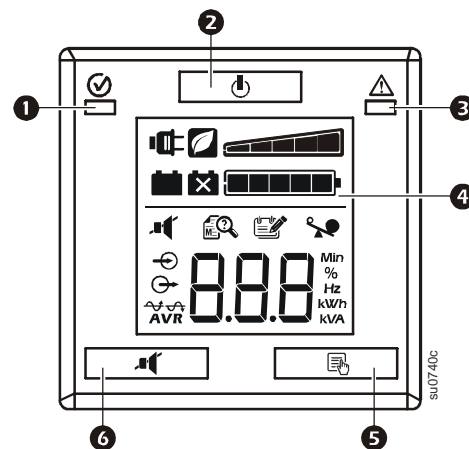

- ❹ Display interface
- ❺ DISPLAY button
- ❻ MUTE button









Note: Refer to “Feature Reference Guide” on page 10 in this manual for a detailed description of the front panel buttons and icons.

## LED status indicators



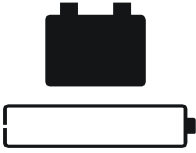













Status	LED	Audible Indicator On	Audible Indicator Terminates
<b>Power On</b> The UPS is supplying utility power to connected equipment.	The <b>On Line/On Battery</b> LED illuminates green	None	N/A
<b>On Battery</b> The UPS is supplying battery power from the internal battery.	The <b>On Line/On Battery</b> LED illuminates amber	The UPS beeps 4 times every 30 seconds.	The beeping stops when utility power is restored or the MUTE button is pressed for two seconds.
<b>System Fault</b> The UPS detects an internal system fault.	System Fault LED illuminates red	Constant tone	The alarm stops when the POWER ON/OFF button is pressed for two seconds. This creates a Fault Reset.
<b>Site Wiring Fault</b> A building wiring fault has occurred. Do not operate the UPS. Contact a qualified electrician to correct the building wiring fault.	<b>Site Wiring Fault</b> LED flashes red	None	N/A



## LCD status indicators

Status	LCD Icon	Audible Alarms	Audible Alarm Terminates
<b>On Battery</b> The UPS is supplying battery power to the connected equipment.		Beeps 4 times every 30 seconds.	The beeping stops when utility power is restored or the UPS is turned off.
<b>Utility Power Overload</b> An overload condition has occurred while the UPS is operating on utility power.		Constant tone	The alarm stops when nonessential equipment is disconnected from the outlets or the UPS is turned off
<b>Battery Power Overload</b> An overload condition has occurred while the UPS is operating on battery power.		Constant tone	The alarm stops when nonessential equipment is disconnected from the outlets or the UPS is turned off.
<b>Low Battery</b> The UPS is supplying battery power to the connected equipment and the battery is near a total discharge state.		Continuous beeping	The beeping stops when utility power is restored or the UPS is turned off.
<b>Battery Fault</b> The UPS is operating on utility power. The battery does not provide expected backup.		The UPS will beep twice to indicate the battery is disconnected. The UPS will beep continuously for one minute every five hours to indicate that the battery should be replaced.	Verify that the battery is securely connected. The battery is nearing the end of its service life and should be replaced.
<b>System Fault</b> The UPS has experienced an internal fault.	120 Vac models  <b>SEE MANUAL</b> 230 Vac models 	N/A	Identify the fault message on the display and refer to <b>System Faults</b> in this manual.

## Display interface features

1000/1500 VA 120 Vac	1000/1500 VA 230 Vac	Description
 <b>ON LINE</b>		<b>On Line:</b> The UPS is supplying conditioned utility power to connected equipment.
		<b>Green mode:</b> The UPS is operating at the most efficient level, bypassing unused AVR components while acceptable utility voltage is present. The UPS will enter and exit Green mode automatically and will not compromise power protection.
		<b>Load Capacity:</b> The load capacity percentage is indicated by the number of load bar sections illuminated. Each bar represents 20% of the load capacity.
<b>ESTIMATED RUN TIME IN MINUTES</b>	<b>Min</b>	<b>Estimated Run Time / Min:</b> This indicates the battery runtime minutes that remain if the UPS switches to battery power.
		<b>Battery Charge:</b> The battery charge level is indicated by the number of load bar sections illuminated. When all five blocks are illuminated, the battery is fully charged. Each bar represents 20% of the battery charge capacity.
		<b>Overload:</b> The equipment connected to the UPS is drawing more power than the voltage rating allows.
<b>EVENT</b>		<b>Event:</b> The event counter indicates the number of events that occurred to cause the UPS to switch to battery operation.
 <b>AVR</b>		<p><b>Automatic Voltage Regulation (AVR):</b> The UPS has an AVR boost and trim feature that automatically regulates high or low levels of input voltage without using battery power. The UPS also features AVR Bypass which temporarily deactivates the AVR circuitry when the input voltage is within normal range. This conserves battery power and helps to maximize battery life.</p> <p> When illuminated, the UPS is compensating for low input voltage.</p> <p> When illuminated, the UPS is compensating for high input voltage.</p>
<b>IN OUT</b>		<b>In:</b> Input voltage. <b>Out:</b> Output voltage.
 <b>SEE MANUAL</b>		<b>System Fault:</b> An internal system fault has occurred. The fault number will illuminate on the display. Refer to <b>“Display interface features” on page 9.</b>
		<b>Mute:</b> An illuminated line through the icon indicates that audible alarms are disabled.
		<b>Battery Fault:</b> The icon will flash to indicate that the battery is disconnected. When the icon remains continuously illuminated the UPS has failed a Self-Test or the battery is near the end of its service life and should be replaced. Refer to <b>“LCD status indicators” on page 8.</b>
		<b>On Battery:</b> The UPS is supplying battery backup power to the connected equipment.

## System Faults

1000/1500 120 Vac

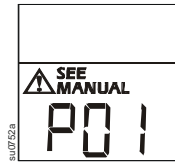

1000/1500 230 Vac

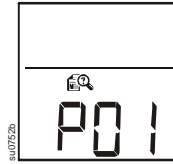

<b>P00</b>	Output Overload
<b>P01</b>	Output Short Circuit
<b>P02</b>	Output Over Voltage
<b>P04</b>	Unit Over Temperature
<b>P06</b>	AVR Relay Fault
<b>P13</b>	Inverter Fault

**Note:** Refer to the “Feature Reference Guide” on page 10 for a detailed description of the front panel buttons and icons.  
**For more information on System Faults, contact customer support at the APC by Schneider Electric Web site, [www.apc.com/support](http://www.apc.com/support).**

## Feature Reference Guide

Function	Button	Timing (seconds)	UPS Status	Description
<b>Power</b>				
Power On		0.2	Off	Press the POWER ON/OFF button to turn on the UPS. The UPS will operate on utility power. If utility power is not available the UPS will operate on battery power.
Power Off		2	On	Press the POWER ON/OFF button to turn off the UPS.
<b>Display</b>				
Status Inquiry		0.2	On	Press to verify the status or condition of the UPS. The LCD will illuminate for 60 seconds.
<b>Power Saving mode</b> Continuous Illumination		2	On	The LCD will illuminate and the UPS will beep to confirm <b>Continuous Illumination</b> mode is activated. The LCD will extinguish and the UPS will beep to confirm that <b>Power Saving</b> mode is activated. While in <b>Power Saving</b> mode, the LCD will illuminate if a button is pressed or an event occurs, then extinguish after 60 seconds of no activity.
<b>Mute</b>				
Event Specific		0.2	On	Disable any audible alarms caused by an event.
Enable/Disable		2	On	Enable or disable the audible alarms. The <b>Mute</b> icon will illuminate and the UPS will beep once.
Sensitivity		6	Off	The <b>Load Capacity</b> icon will flash to indicate the UPS is in <b>Program</b> mode. Use the POWER ON/OFF button to scroll through and select Low, Medium, and High sensitivity levels. The UPS will beep to confirm the selection. Refer to “Sensitivity adjustment settings” on page 6 in this manual.
Self-Test		2	On	The UPS will automatically run a Self-Test of the internal battery when the UPS is turned on. A manual Self-Test can be run at any time while the UPS is operating. Press and hold the MUTE button, then press the DISPLAY button for 2 seconds until the system emits a short beep to indicate the UPS has started a Self-Test.
Event Reset		0.2	On	When the <b>Event</b> screen is visible, press and hold the DISPLAY button, then press the POWER ON/OFF button to clear the utility failure event counter.
Fault Reset		2	Fault	After a fault has been identified, press the POWER ON/OFF button. The icon will extinguish and the UPS will go to standby mode.

# Troubleshooting

<b>Problem and Possible Cause</b>	<b>Solution</b>
<b>The UPS will not turn on or there is no output</b>	
The UPS has not been turned on.	Press the ON button once to turn on the UPS.
The UPS is not connected to utility power.	Be sure the power cable is securely connected to the UPS and to the utility power supply.
The input circuit breaker has tripped.	Disconnect nonessential equipment and reset the circuit breaker.
The UPS shows very low or no input voltage.	Check the utility power supply to the UPS by plugging in a table lamp. If the light is very dim, check the utility voltage.
The battery is not securely connected.	Be sure that all battery connections are secure.
There is an internal UPS fault.	Do not attempt to use the UPS. Unplug the UPS and have it serviced immediately.
<b>The UPS is operating on battery while connected to utility power</b>	
The input circuit breaker has tripped.	Disconnect nonessential equipment and reset the circuit breaker.
There is very high, very low, or distorted input line voltage.	Move the UPS to a different outlet on a different circuit. Test the input voltage with the utility voltage display. If acceptable to the connected equipment, reduce the UPS sensitivity.
<b>The UPS is beeping</b>	
The UPS is operating normally.	None. The UPS is protecting the connected equipment.
<b>The UPS does not provide expected battery backup time</b>	
The UPS battery is weak due to a recent power outage or is near the end of its service life.	Charge the battery. Batteries require recharging after an extended outage. Elevated ambient temperatures, poor quality utility power, and frequent short duration discharges will shorten battery life. If the battery is near the end of its service life, consider replacing the battery even if the replace battery icon is not illuminated.
The UPS is experiencing an overload condition.	Check the UPS load display. Unplug nonessential equipment, such as printers.
<b>The Fault LED is illuminated, the UPS displays a fault message and emits a constant beeping</b>	
Internal UPS fault.	Do not attempt to use the UPS. Turn the UPS off and have it serviced immediately. If more than one fault is present the fault messages will be displayed alternately on the display screen.
<b>The Replace Battery icon is illuminated</b>	
The battery has a weak charge.	Allow the battery to recharge for at least four hours. Then, perform a Self-Test. If the problem persists after recharging, replace the battery.
The replacement battery is not properly connected.	Be sure the battery connector is securely connected.
<b>Site Wiring Fault LED is flashing</b>	
Wiring faults detected include missing ground, hot-neutral, polarity reversal, and overloaded neutral circuit.	If the UPS indicates a site wiring fault, have a qualified electrician inspect the building wiring. Applicable for 120 Vac units only.

# Service and Transport

---

If the unit requires service, do not return it to the dealer. Follow these steps:

1. Review the *Troubleshooting* section of the manual to eliminate common problems.
2. If the problem persists, contact APC by Schneider Electric Customer Support through the APC by Schneider Electric Web site, [www.apc.com](http://www.apc.com).
  - a. Note the model number and serial number and the date of purchase. The model and serial numbers are located on the rear panel of the unit and are available through the LCD display on select models.
  - b. Call APC by Schneider Electric Customer Support and a technician will attempt to solve the problem over the phone. If this is not possible, the technician will issue a Returned Material Authorization Number (RMA#).
  - c. If the unit is under warranty, the repairs are free.
  - d. Service procedures and returns may vary internationally. Refer to the APC by Schneider Electric Web site for country specific instructions.
3. Pack the unit in the original packaging whenever possible to avoid damage in transit. Never use foam beads for packaging. Damage sustained in transit is not covered under warranty.
  - a. **Always DISCONNECT THE UPS BATTERIES before shipping. The United States Department of Transportation (DOT), and the International Air Transport Association (IATA) regulations require that UPS batteries be disconnected before shipping.** The internal batteries may remain in the UPS.
  - b. External Battery Pack products are deenergized when disconnected from the associated UPS product. It is not necessary to disconnect the internal batteries for shipping. Not all units utilize an external battery pack.
4. Write the RMA# provided by Customer Support on the outside of the package.
5. Return the unit by insured, prepaid carrier to the address provided by Customer Support.

## Transport the unit

1. Shut down and disconnect all connected equipment.
2. Disconnect the unit from utility power.
3. Disconnect all internal and external batteries (if applicable).
4. Follow the shipping instructions outlined in the *Service* section of this manual.

# Two Year Limited Factory Warranty

---

This warranty applies only to the products you purchase for your use in accordance with this manual.

## Terms of warranty

Schneider Electric IT (SEIT) warrants its products to be free from defects in materials and workmanship for a period of two years from the date of purchase. SEIT will repair or replace defective products covered by this warranty. This warranty does not apply to equipment that has been damaged by accident, negligence or misapplication or has been altered or modified in any way. Repair or replacement of a defective product or part thereof does not extend the original warranty period. Any parts furnished under this warranty may be new or factory remanufactured. For country specific warranty information, refer to the APC by Schneider Electric Web site at [www.apc.com](http://www.apc.com).

## Non-transferable warranty

This warranty extends only to the original purchaser who must have properly registered the product. The product may be registered at the APC by Schneider Electric Web site, [www.apc.com](http://www.apc.com).

## Exclusions

SEIT shall not be liable under the warranty if its testing and examination disclose that the alleged defect in the product does not exist or was caused by end user's or any third person's misuse, negligence, improper installation or testing. Further, SEIT shall not be liable under the warranty for unauthorized attempts to repair or modify wrong or inadequate electrical voltage or connection, inappropriate on site operation conditions, corrosive atmosphere, repair, installation, exposure to the elements, Acts of God, fire, theft, or installation contrary to SEIT recommendations or specifications or in any event if the SEIT serial number has been altered, defaced, or removed, or any other cause beyond the range of the intended use.

**THERE ARE NO WARRANTIES, EXPRESS OR IMPLIED, BY OPERATION OF LAW OR OTHERWISE, OF PRODUCTS SOLD, SERVICED OR FURNISHED UNDER THIS AGREEMENT OR IN CONNECTION HEREWITH. SEIT DISCLAIMS ALL IMPLIED WARRANTIES OF MERCHANTABILITY, SATISFACTION AND FITNESS FOR A PARTICULAR PURPOSE. SEIT EXPRESS WARRANTIES WILL NOT BE ENLARGED, DIMINISHED, OR AFFECTED BY AND NO OBLIGATION OR LIABILITY WILL ARISE OUT OF, SEIT RENDERING OF TECHNICAL OR OTHER ADVICE OR SERVICE IN CONNECTION WITH THE PRODUCTS. THE FOREGOING WARRANTIES AND REMEDIES ARE EXCLUSIVE AND IN LIEU OF ALL OTHER WARRANTIES AND REMEDIES. THE WARRANTIES SET FORTH ABOVE CONSTITUTE SEIT'S SOLE LIABILITY AND PURCHASER'S EXCLUSIVE REMEDY FOR ANY BREACH OF SUCH WARRANTIES. SEIT WARRANTIES EXTEND ONLY TO PURCHASER AND ARE NOT EXTENDED TO ANY THIRD PARTIES.**

**IN NO EVENT SHALL SEIT, ITS OFFICERS, DIRECTORS, AFFILIATES OR EMPLOYEES BE LIABLE FOR ANY FORM OF INDIRECT, SPECIAL, CONSEQUENTIAL OR PUNITIVE DAMAGES, ARISING OUT OF THE USE, SERVICE OR INSTALLATION, OF THE PRODUCTS, WHETHER SUCH DAMAGES ARISE IN CONTRACT OR TORT, IRRESPECTIVE OF FAULT, NEGLIGENCE OR STRICT LIABILITY OR WHETHER SEIT HAS BEEN ADVISED IN ADVANCE OF THE POSSIBILITY OF SUCH DAMAGES. SPECIFICALLY, SEIT IS NOT LIABLE FOR ANY COSTS, SUCH AS LOST PROFITS OR REVENUE, LOSS OF EQUIPMENT, LOSS OF USE OF EQUIPMENT, LOSS OF SOFTWARE, LOSS OF DATA, COSTS OF SUBSTITUENTS, CLAIMS BY THIRD PARTIES, OR OTHERWISE.**

**NO SALESMAN, EMPLOYEE OR AGENT OF SEIT IS AUTHORIZED TO ADD TO OR VARY THE TERMS OF THIS WARRANTY. WARRANTY TERMS MAY BE MODIFIED, IF AT ALL, ONLY IN WRITING SIGNED BY AN SEIT OFFICER AND LEGAL DEPARTMENT.**

## Warranty claims

Customers with warranty claims issues may access the SEIT customer support network through the Support page of the APC by Schneider Electric Web site, [www.apc.com/support](http://www.apc.com/support). Select your country from the country selection drop down menu at the top of the Web page. Select the Support tab to obtain contact information for customer support in your region.

# APC by Schneider Electric Worldwide Customer Support

Customer support for this or any other APC by Schneider Electric product is available at no charge in any of the following ways:

- Visit the APC by Schneider Electric Web site to access documents in the APC by Schneider Electric Knowledge Base and to submit customer support requests.
  - **www.apc.com** (Corporate Headquarters)  
Connect to localized APC by Schneider Electric Web sites for specific countries, each of which provides customer support information.
  - **www.apc.com/support/**  
Global support searching APC by Schneider Electric Knowledge Base and using e-support.
- Contact the APC by Schneider Electric Customer Support Center by telephone or e-mail.
  - Local, country-specific centers: go to **www.apc.com/support/contact** for contact information.
  - For information on how to obtain local customer support, contact the APC by Schneider Electric representative or other distributors from whom you purchased your APC by Schneider Electric product.



Select models are ENERGY STAR<sup>®</sup> qualified.

For more information go to [www.apc.com/site/recycle/index.cfm/energy-efficiency/energy-star/](http://www.apc.com/site/recycle/index.cfm/energy-efficiency/energy-star/)

© 2013 APC by Schneider Electric. APC, the APC logo, Smart-UPS and PowerChute are owned by Schneider Electric Industries S.A.S. or their affiliated companies. All other trademarks are property of their respective owners.