

# Galaxy High Efficiency Modes

By Jesper Johnsen, Kristian Budde 

## PROJECT AT A GLANCE

### Project Type

High Efficiency Modes

### Equipment Installed

Galaxy VM

Galaxy VX

Rev 3.



The Galaxy (VM and VX) UPS offers two types of high efficiency modes: ECO Mode and EConversion Mode.

Common for both high efficiency modes is that the static bypass switch is used for powering the load through the bypass path. This will reduce power loss as the efficiency of the bypass path is typically around 98% to 99%. This also means that the load is more exposed to unconditioned utility power, and the UPS must therefore monitor the bypass power, react on occurring events and transfer back to inverter operation when needed.

The fundamental difference between ECO Mode and EConversion Mode is that the inverter is off in ECO Mode whereas it is on in EConversion Mode. This means that the load is exposed directly to the unconditioned utility power in ECO Mode, this is not the case in EConversion Mode. Here the inverter is able to run in parallel with the bypass source supplying the reactive part of the load and maintain an input power factor close to unity. In EConversion Mode it is possible to transfer back to inverter operation faster compared to ECO Mode, should it be required.

Keeping the inverter on in EConversion Mode has a small impact on the efficiency. The efficiency is around 99% in ECO Mode and in EConversion up to 99% depending on the connected load.

## [ APPLICATION NOTE #187 ] Galaxy High Efficiency Modes

In this context the general term 'high efficiency mode' is defined as an UPS operation mode for which the primary goal is to reduce the system power loss and increase the efficiency compared to inverter operation (battery or normal operation).

### ECO MODE

ECO Mode is basically the same as transferring the UPS to Requested Static Bypass as its primary mode of operation. The static bypass switch is supplying the load with unconditioned utility power and the inverter is off. If some sort of disturbance is detected on the bypass utility the UPS will transfer to inverter operation. In a worst case scenario this can lead to a 8 ms (at 60 Hz) or 10 ms (at 50 Hz) interruption in the output voltage.

The UPS can only be in, or transfer to, ECO Mode (or Requested Static Bypass) if all of the below conditions are fulfilled:

- The bypass utility is within the configured tolerance.
- There is no surveillance detected faults in the inverter and static bypass switch.
- The inverter is synchronized to bypass.

To avoid transferring in and out of ECO Mode because of small variations and disturbances in the bypass utility, it is recommended to keep the output voltage tolerance setting at the default value of +/- 10%.

### User Interface

There are some consequences connected with the use of ECO Mode concerning the protection of the power to the load. It is therefore by default disabled and cannot be enabled by the customer. An FSE is required to enable the ECO Mode feature in the UPS using UPSTuner, and at the same time notify the customer about possible risks and benefits.

When ECO Mode is enabled by the FSE, the customer can configure how and when ECO Mode should be used via the UPS display.

### Setup and Configuration

The following parameters can be configured for ECO Mode:

- **High Efficiency Mode:** Configures which high efficiency mode the UPS should use. Value can be 'None', 'ECO Mode' or 'ECOConversion'. Must be set to ECO Mode.
- **ECO Mode enable/disable:** General setting to enable and disable use of the ECO Mode feature in the UPS. Can only be configured via UPSTuner.
- **High Efficiency Mode Setup:** Configures when the UPS transfers to ECO Mode. Selectable values are 'Never', 'Always' and 'Scheduled'.
  - If 'Never' is selected, the UPS will not enter ECO Mode under any circumstances.
  - If 'Always' is selected, the UPS will transfer to ECO Mode whenever circumstances allow it and stay in this mode as long as circumstances allow it. ECO Mode will be the primary operation mode of the UPS.
  - If 'Scheduled' is selected, the user can configure when the UPS must enter and exit ECO Mode. Up to seven different time intervals can be configured, each with a start time, a start day, a stop time and a stop day. Each of the seven intervals can be enabled and disabled separately. One interval may span over several days. The intervals must not overlap each other.

Below are some screenshots of the high efficiency mode configuration screens on the display and in UPSTuner:

[ APPLICATION NOTE #187 ] Galaxy High Efficiency Modes

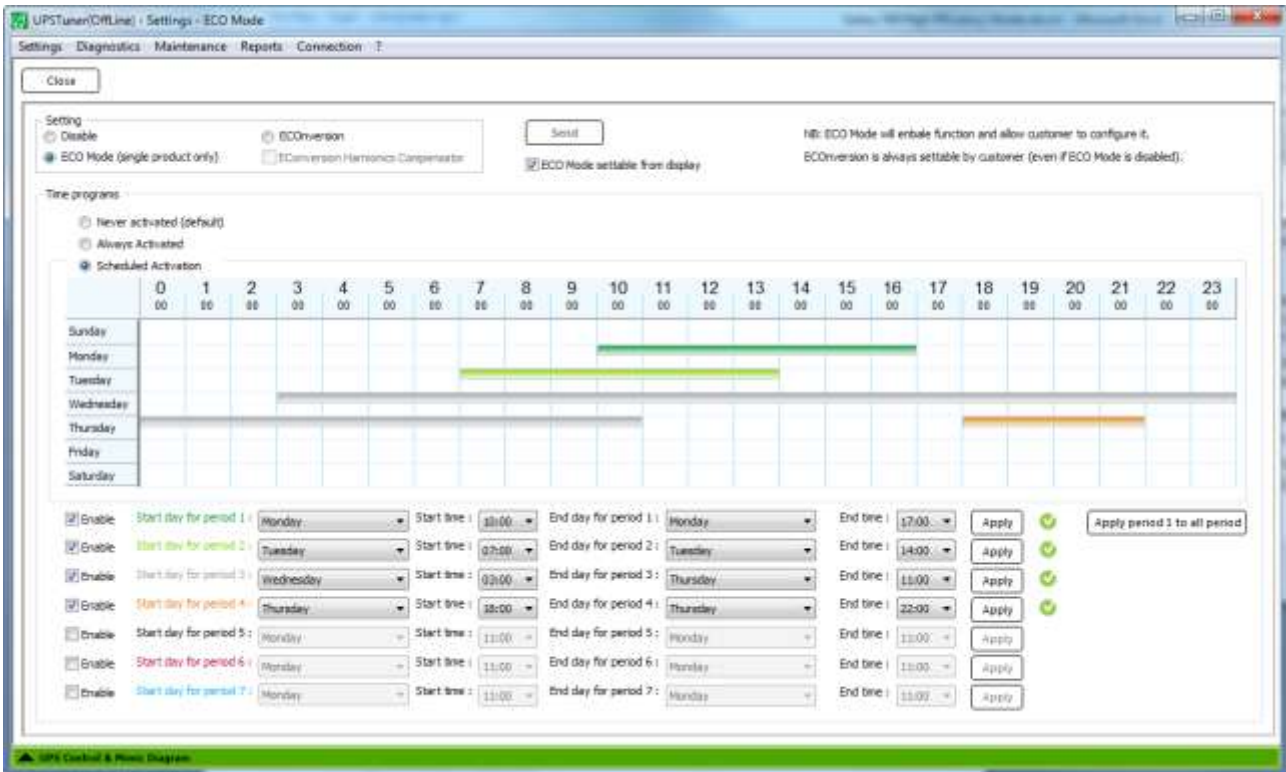

Figure 1: Screenshot of the high efficiency mode configuration screen in UPSTuner.

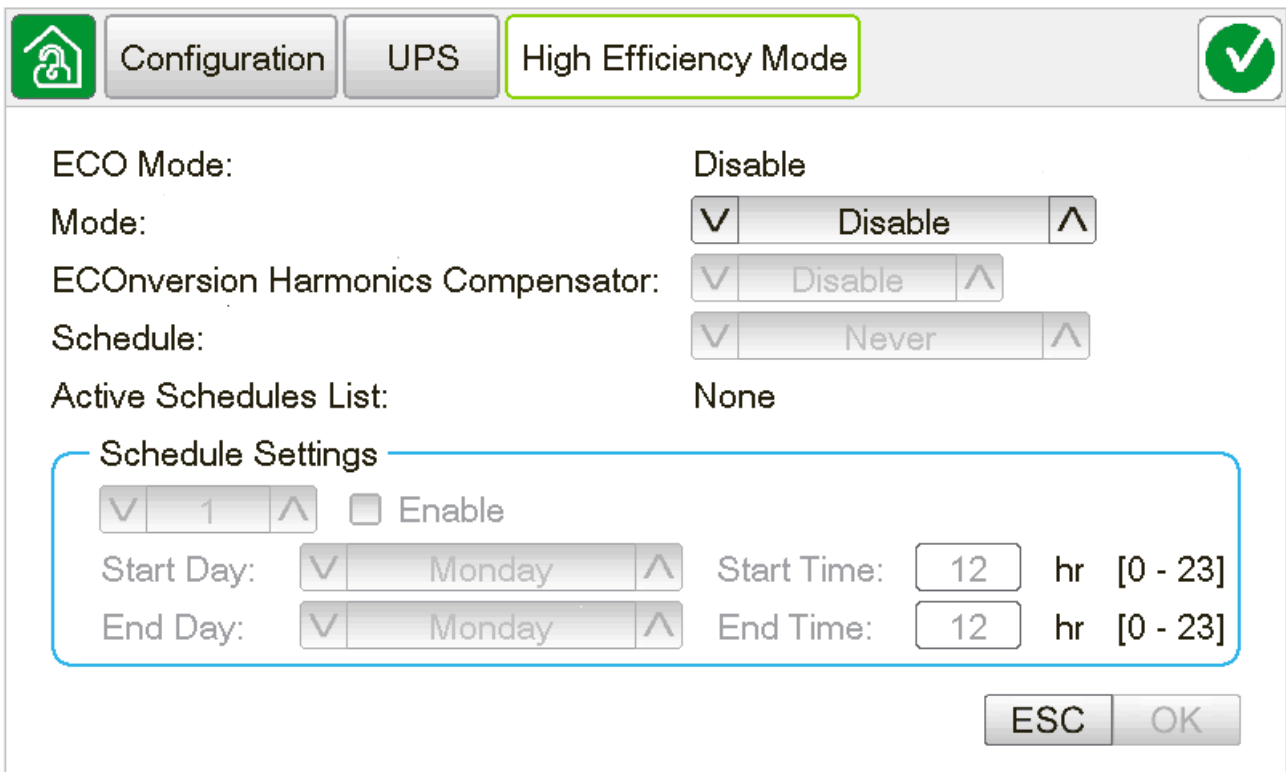

Figure 2: The high efficiency mode configuration screen in the UPS display.

## [ APPLICATION NOTE #187 ] Galaxy High Efficiency Modes

### Operation

When the UPS is in ECO Mode, this will be indicated as both the system and the UPS operation mode in the UPS display and UPSTuner.

The UPS mimic diagram will indicate ECO Mode in the following way:

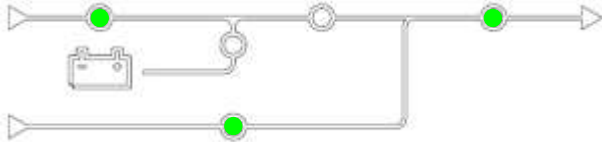

**Figure 3:** Mimic diagram indication of ECO Mode

### ECONVERSION MODE

In EConversion Mode the primary power path is the same as for ECO Mode described in the previous section, but in EConversion Mode the inverter is on and operating in parallel with bypass. Using this mode, the inverter is not continuously regenerating output power to the load like in double conversion mode. Instead the load is receiving unconditioned bypass power.

The main advantage of EConversion Mode is that the inverter can seamlessly take over support the load in

cases of bypass utility failure. The inverter is furthermore able to correct the power factor of the load and actively filter harmonic currents generated by the load.

### Bypass Failure

When in EConversion Mode, the inverter is operating in parallel with bypass. Thus, the inverter is continually powered and ready to take over in case of a bypass utility failure. In Figure 4 a case is shown where bypass utility is failing caused by an over current protective device supplying the UPS. The bypass utility supplying the UPS is disconnected from the inverter without changing the inverter output voltage level and the supplied load voltage level. The handover of power is easily seen on the bypass and inverter current measurement but difficult to notice on the output UPS voltage.

In Figure 5 the same scenario is repeated with an UPS in ECO Mode. The inverter voltage is much more affected by the fault occurring. In this specific case there is a break in the output UPS voltage of 4 ms before the inverter supplies the load.

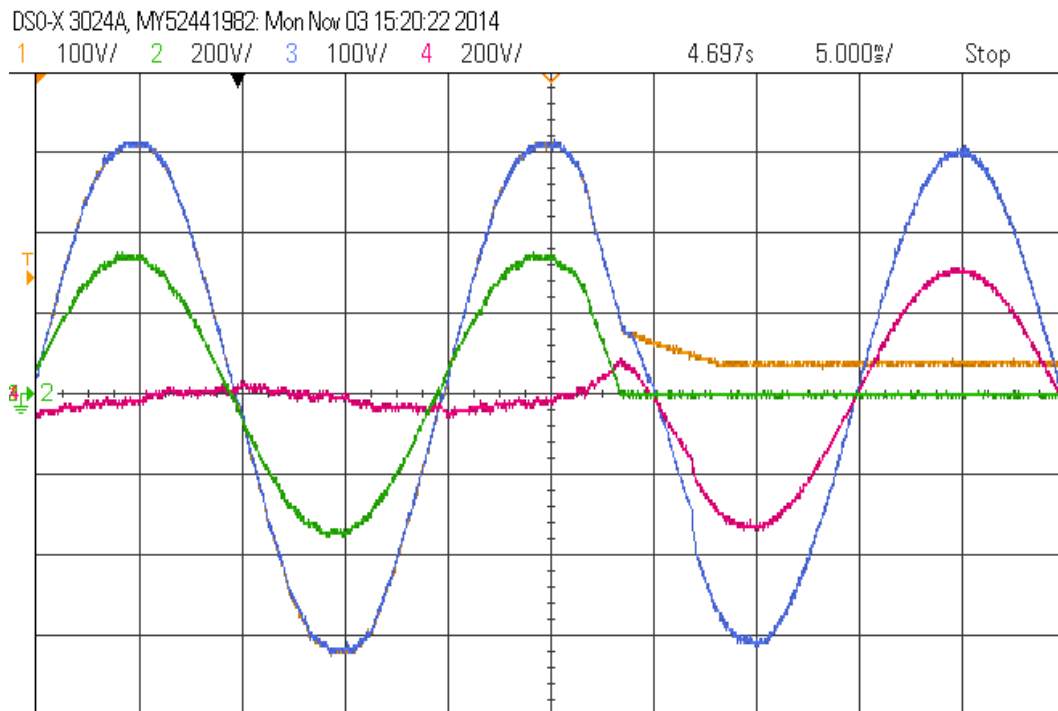

**Figure 4:** Situation with 95% ohm load applied on a 4-wire 400 V 50 Hz system.

Blue Inverter V, Red Inverter I, Yellow Bypass V, Green Bypass I

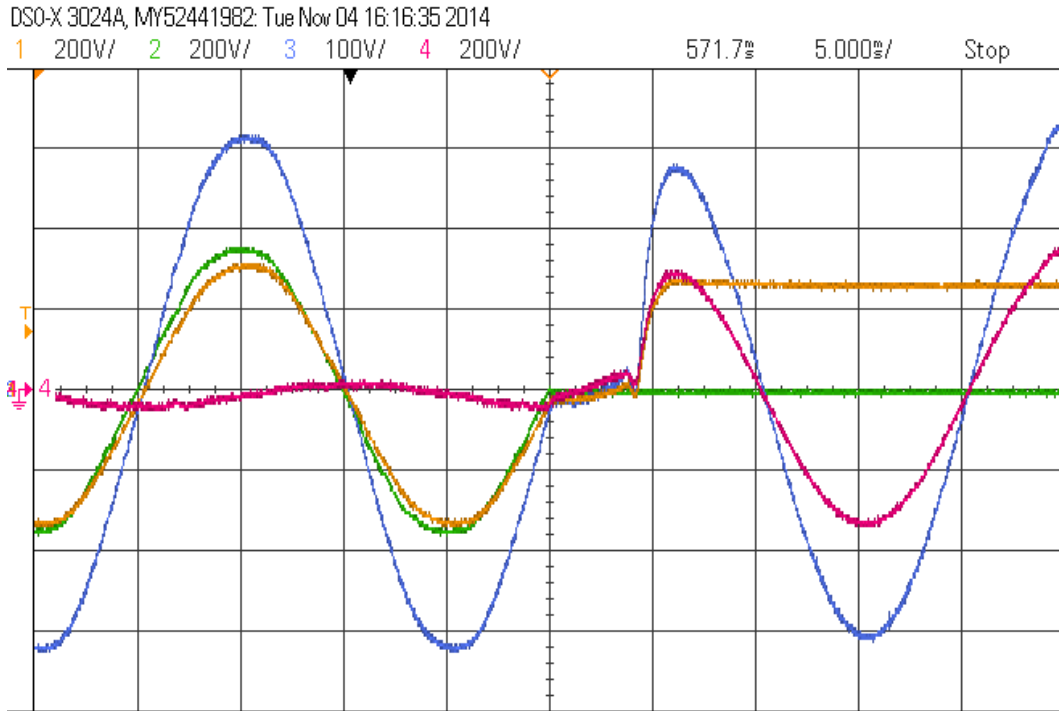

**Figure 5:** Situation with 95% ohm load applied on a 4-wire 400 V 50 Hz system.  
Blue Inverter V, Red Inverter I, Yellow Bypass V, Green Bypass I

This difference illustrates an important strength of EConversion Mode compared to ECO Mode where the prolonged detection time and powering of the inverter changes the given scenario significantly. This power failure scenario is a more common situation and a situation where EConversion Mode, supporting customer loads, can be a reliable mode of operation.

Bypass scenarios including transients like illustrated on Figure 6 are not handled equally well when in EConversion mode compared to the complete suppression achieved in double conversion. In EConversion a common mode transient is reduced approximately 7 times and a difference mode transient

is reduced approximately 15 times giving a significant but no complete reduction of transients.

A situation with an abrupt change in bypass voltage is detected and reacted upon after 1 ms (the detection time of any waveform disruption when in EConversion). The reaction time for a sinusoidal RMS fault can be up to 200 ms, which is again too long for a reaction to occur in the case of a sub-cycle overvoltage like illustrated on Figure 7. Even if the faults were detected in time, it would not be possible to avoid the power from the sub-cycle overvoltage to pass through the bypass switch before next zero crossing since the SCR would continue to conduct even if it was turned off.

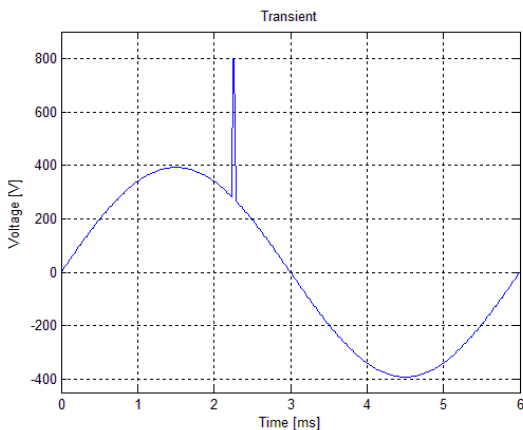

**Figure 6:** Transient occurring on grid

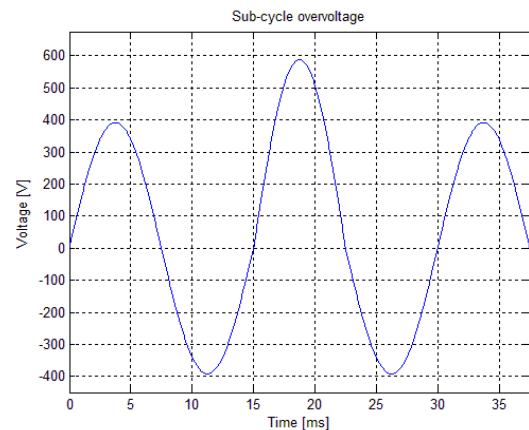

**Figure 7:** Sub-cycle overvoltage

## [ APPLICATION NOTE #187 ] Galaxy High Efficiency Modes

In other situations where transients are decreasing towards zero, or during a sub-cycle under voltage, the inverter is immediately able to support the load avoiding the grid fault to affect the connected load.

The power generated by the inverter is not reversed through bypass to utility mains since bypass is operating as one directional conductor during the operation mode of EConversion Mode.

### Upstream and Downstream Short

In ECO Mode the static bypass switch is operating as a bidirectional conductor able to conduct current to and from the load. This is not the case when operating in EConversion Mode. In EConversion an advanced method of bypass operation is used (patent pending 2012/0181871). This method enables the UPS to handle occurring upstream short as illustrated in Figure 8 where a short forces bypass input to zero. From the bypass current it can be seen that no current is

conducted upstream, and the inverter voltage shows that the load is continually supplied. The upstream short occurs at 180 degrees and in a no load situation, since this is one of the most difficult situations for the UPS to handle.

In Figure 9 the same test is conducted with an UPS in ECO Mode. In this case the inverter output voltage is forced to zero from the occurring upstream short until next zero crossing where both bypass SCR's are able to stop conducting. In this period, the inverter tries to take over from bypass but the inverter current is conducted from the inverter through bypass to the upstream short and therefore not powering the load, and in this case not able to clear the upstream fault. The resonance observed on bypass and inverter voltage, together with bypass current, is a result of the capacitance and inductance present on the grid and connected systems.

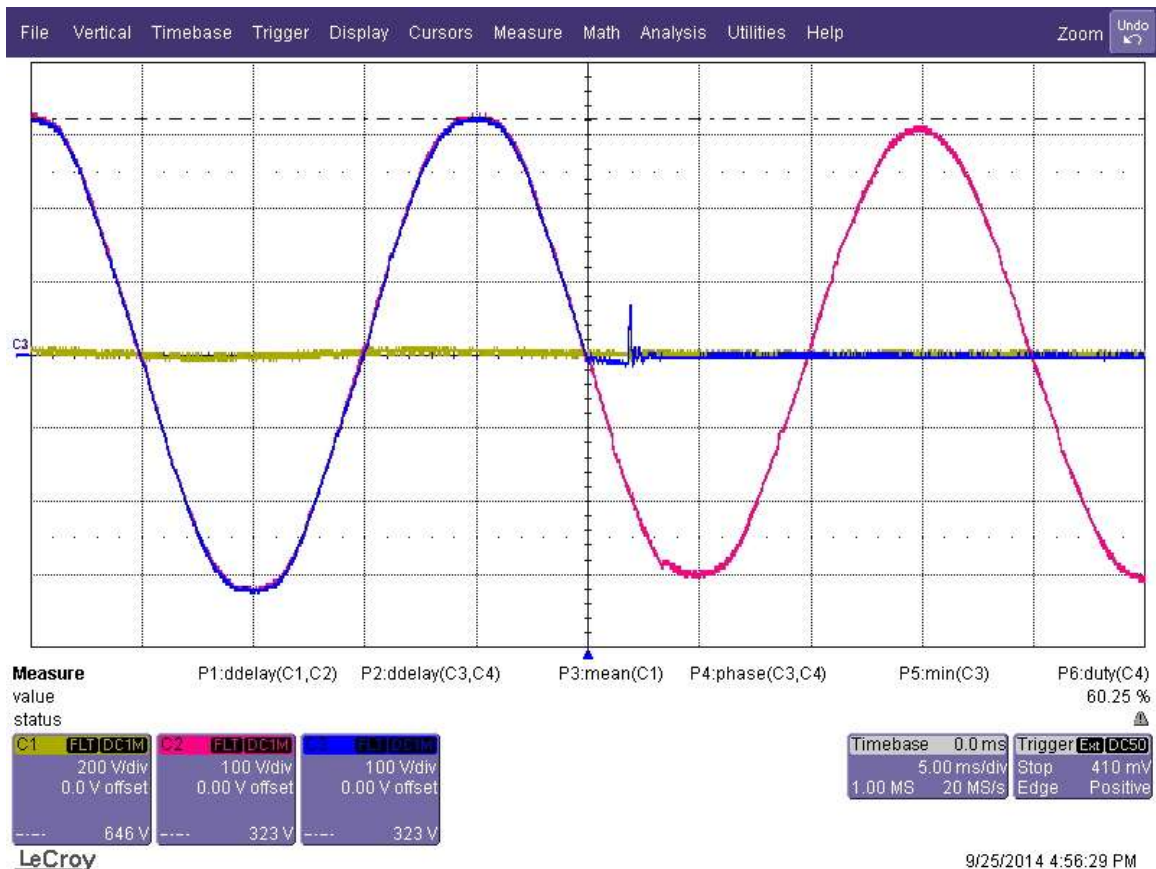

**Figure 8:** Upstream short when systems in EConversion Mode 0% load short at 180 degrees.

Blue bypass V, yellow bypass I, red inverter V,

[ APPLICATION NOTE #187 ] Galaxy High Efficiency Modes

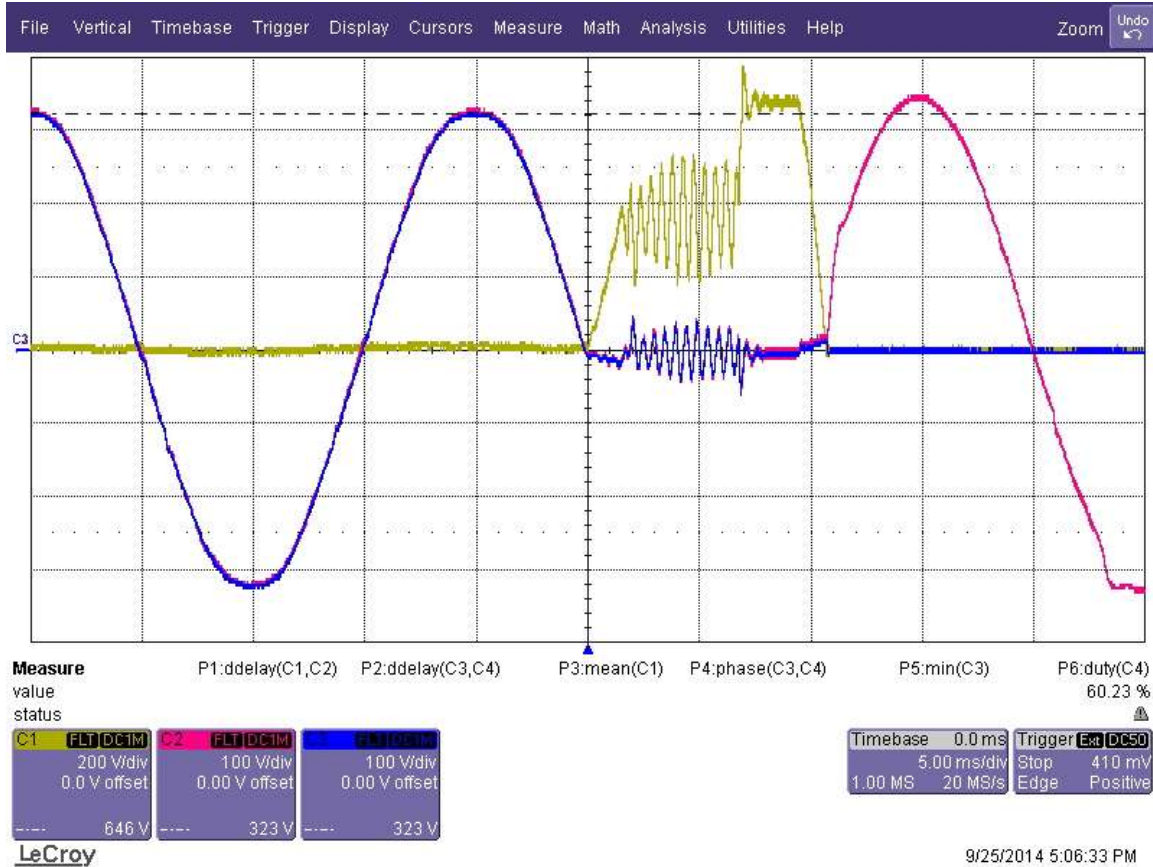

**Figure 9:** Upstream short when systems in ECO Mode 0% load short at 180 degrees.  
Blue bypass V, yellow bypass I, red inverter V,

In a case with a downstream short ECO Mode and ECOConversion Mode have different reaction patterns compared to normal operation. A system in normal operation, which is experiencing a downstream short, will based on the large inverter current transfer to static bypass. This ensures the largest possible current resulting in a rapid clearing of a downstream protective device.

An UPS operating in ECO Mode or ECOConversion Mode is supplying the load through bypass. This enables a high immediate current to clear the downstream protective device, but based on an occurring output voltage waveform fault, the system will transfer to inverter operation. If the waveform fault is not cleared before transferring to inverter operation, the downstream current is limited to the abilities of the inverter. If this is not sufficient, the UPS returns to

bypass operation increasing the abilities to clear downstream.

If the downstream short is cleared before transferring to inverter operation, then ECOConversion Mode and ECO Mode have supplied the load with the best protection. If the downstream short is not cleared when in bypass operation then the transfer process from bypass to inverter operation and then back to bypass take more time than it would in a system in normal operation and is therefore less ideal.

**ECOConversion is a class 1 operation**

Based on possible outage situations the UPS when operating in ECOConversion is able to react as a class 1 system according to ICE 62040-3. As illustrated in Figure 10 the system output voltage is kept within limits of a class 1 system rating.

## [ APPLICATION NOTE #187 ] Galaxy High Efficiency Modes

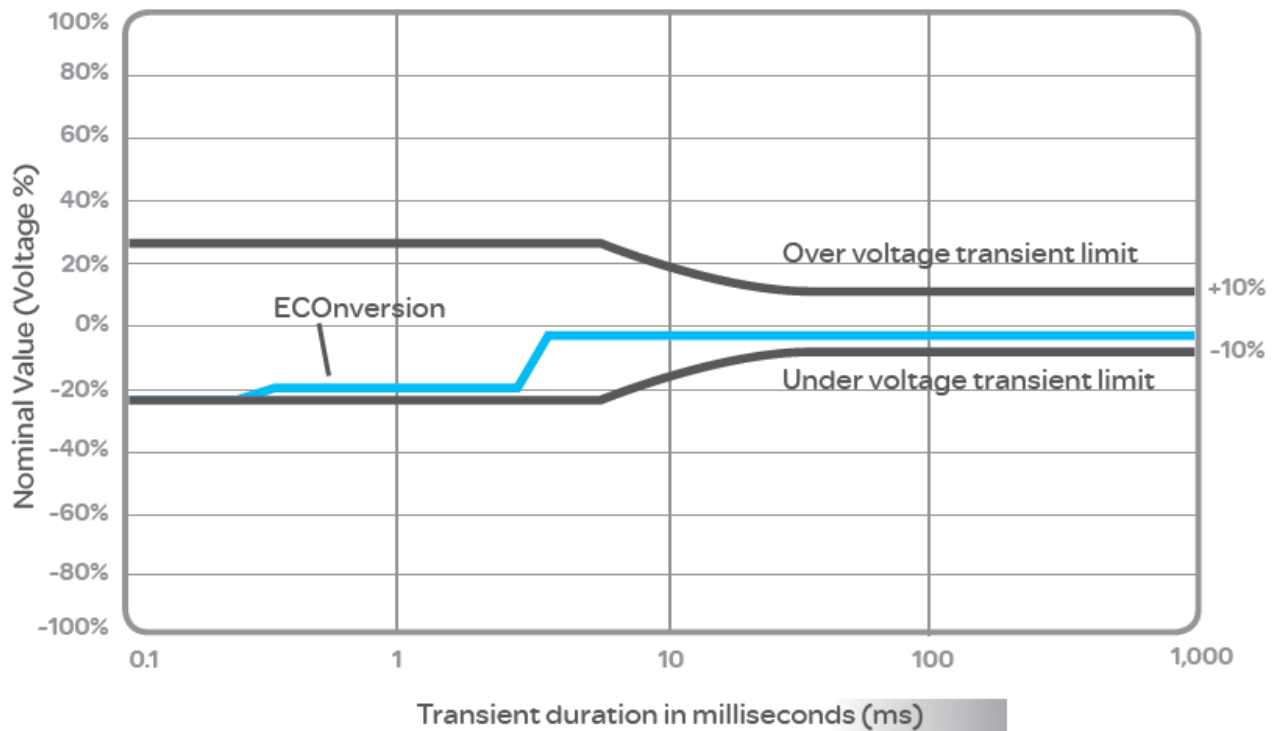

**Figure 10:** In EConversion mode the UPS is rated as a class 1 system giving zero breaks transfer at power outage (ICE 62040-3).

### PFC Off and Contactor Open

In order to decrease UPS power consumption when operating in EConversion Mode, the PFC rectifier is turned off. The system DC bus powering fans, controller, battery charger, etc. is being powered through the inverter using power from bypass.

In Figure 11 the power flow in ECO Mode is shown and the inverter is not active in charging the DC bus. Figure 12 illustrates the power flow in EConversion Mode where the DC bus is being powered from the inverter via bypass. This allows for increased system efficiency while maintaining all system functionalities. As a consequence of this, each transfer from EConversion Mode to normal operation must first rely on power from the batteries until the UPS has closed its input contactors and can draw power from the grid. This will typically result in batteries partly supplying the load for 20 seconds (adjustable) during ramp-in to mains power and will have little or no effect on the charge state of the batteries.

However, this could have an effect on the battery life cycle if EConversion Mode is chosen in an installation where transfer to inverter operation is often required. Conducting many small discharges on a battery installation can decrease the overall life expectancy of

the installed batteries and is one of the reasons for the recommendation to only use EConversion Mode in installations supplied by a reliable power grid of reasonable good quality requiring few transfers from EConversion Mode to inverter operation.



## [ APPLICATION NOTE #187 ] Galaxy High Efficiency Modes

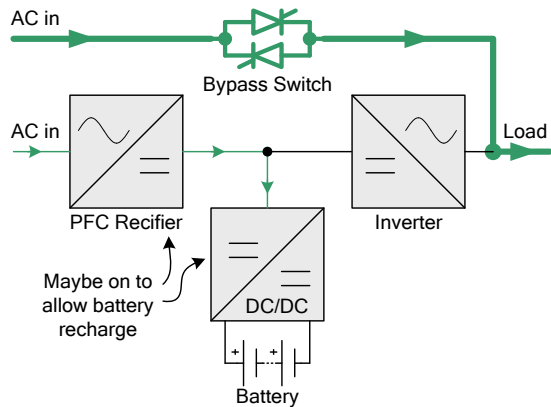

**Figure 11:** In ECO Mode the DC bus is being charged through the PFC to allow the batteries to be charged.

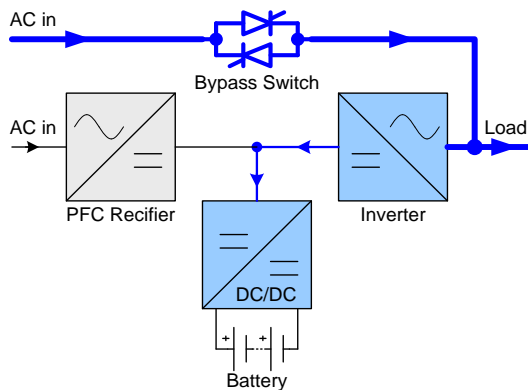

**Figure 12:** In EConversion Mode the DC bus is being charged through the inverter to allow the batteries to be charged.

### Harmonic Compensation and Power Factor

When operating in ECO Mode the bypass utility will receive whatever power factor and harmonic currents the load generates. This is not the case when operating in EConversion Mode. Here the inverter operating in parallel with bypass is able to correct system power factor ensuring power drawn from mains at unity power factor. It is further possible to select a suppression of harmonic currents. This enables the inverter to operate as an active filter removing most of the harmonics current content of the connected load. In practice the system is able to suppress 3', 5' and 7' harmonics since these are typically carrying the significantly largest part of the total harmonic content.

Figure 13 illustrates a SMPS load connected to a UPS in EConversion Mode with harmonic suppression disabled. The harmonic content of the bypass current is

high and even though the inverter is supporting the output voltage shape, it is not controlling the harmonics.

The next figure (Figure 14) illustrates the bypass current drawn by the same SMPS load, but with harmonic compensation enabled. Note that the bypass current is now more sinusoidal shaped. The inverter is working to decrease the harmonics currents generated by the load giving a unique shape of the inverter current.

The harmonics content on bypass when enabling harmonic suppression is significantly decreased as can be seen in Table 1.

This shielding of the harmonic currents generated by the load and correction of power factor protects the utility or generator power source.

Suppression of harmonic currents is by default enabled but can, though it is not recommended, be turned off if required. Correction of power factor is by default on and can only be disabled by exiting EConversion Mode and transferring to ECO Mode.

Operation of loads where the total load is generating power (regenerative loads) is not supported by EConversion.

[ APPLICATION NOTE #187 ] Galaxy High Efficiency Modes

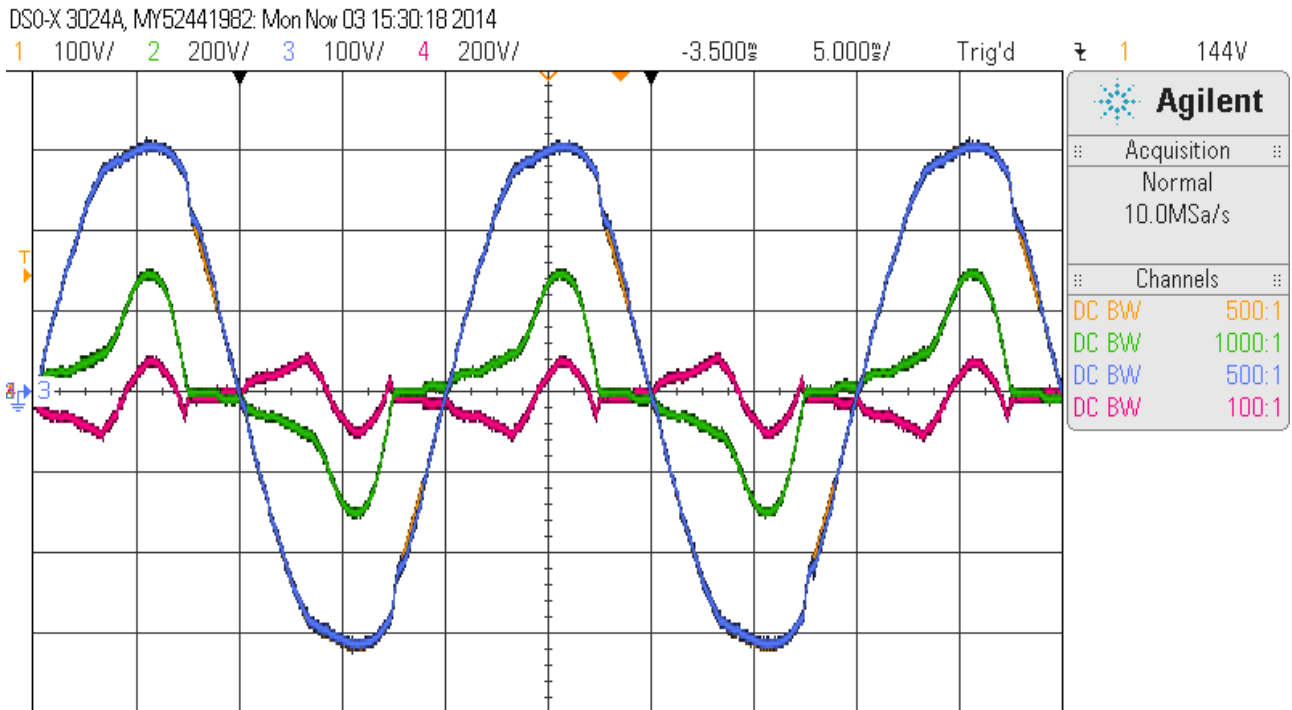

**Figure 13:** Situation with 60% SMPS load applied on at 4-wire 400 V 50 Hz system.  
 Blue Inverter V, Red Inverter I, Yellow Bypass V, Green Bypass I

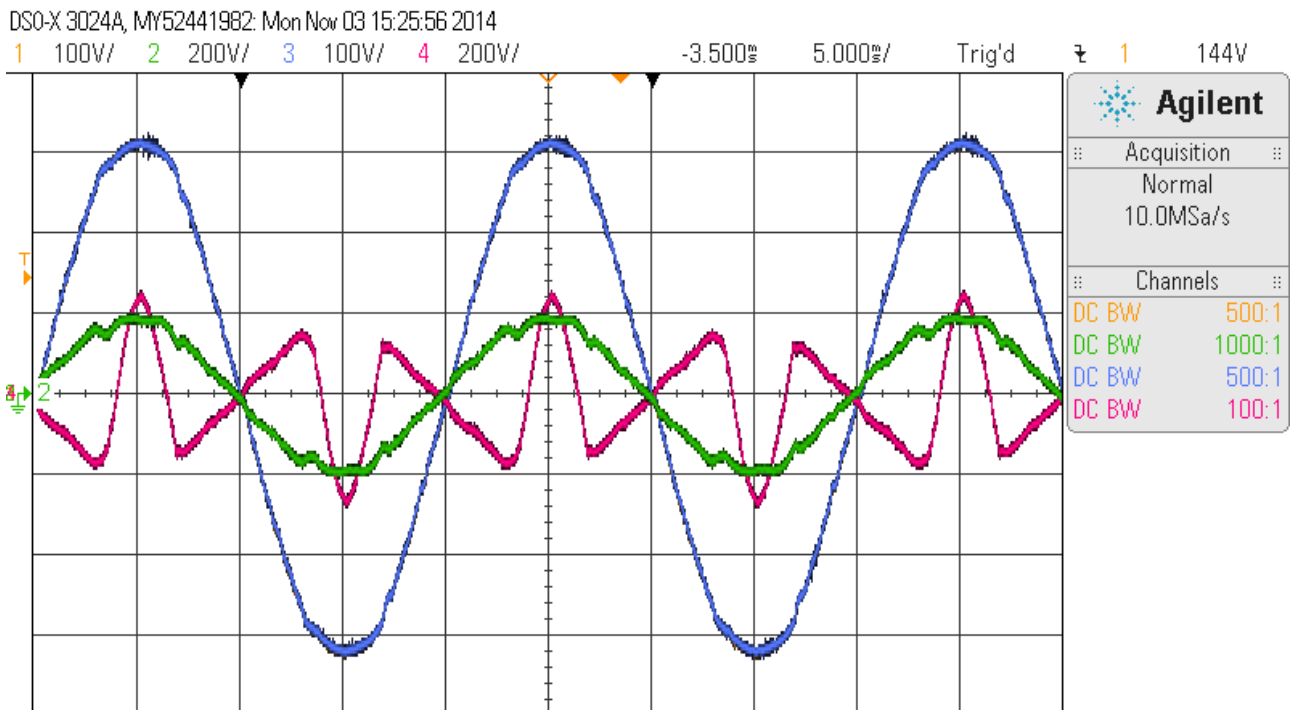

**Figure 14:** Situation with 60% SMPS load applied on at 4-wire 400 V 50 Hz system.  
 Blue Inverter V, Red Inverter I, Yellow Bypass V, Green Bypass I

[ APPLICATION NOTE #187 ] Galaxy High Efficiency Modes

Table 1: Harmonic content in ECO Mode compared to EConversion when 60% SMPS load is applied

	ECO Mode	EConversion Mode
Harmonic	Input current harmonics [%]	Input current harmonics [%]
H3	40	2.50
H5	21	2.25
H7	7	1.07

**Efficiency in EConversion Mode**

Given that the reason for choosing EConversion Mode as operation mode is to decrease power consumption of an installation, it is interesting to compare the loss related to the different modes of operation. Besides saving energy on the UPS as an isolated system, an additional energy saving can in some cases be achieved on UPS cooling. The evaluation of this is much more individual since it depends on the installation and chosen method of cooling (e.g. air-conditioning, ventilation) and must therefore be evaluated for the specific installation.

In Figure 15 an efficiency plot of a 200 kVA UPS in normal operation, ECO Mode and EConversion Mode can be observed. With 50% resistive load there is a gain in efficiency from 96.37% in double conversion to 98.64% in EConversion Mode. This is a significant improvement of the UPS efficiency by up to 2.27%. The efficiency improvement in EConversion mode is dependent on the load type applied to the UPS. The more the inverter has to compensate the load current the less improvement in efficiency will be achieved compared to double conversion. For further details regarding applied load and the resulting EConversion efficiency refer to appendix A.

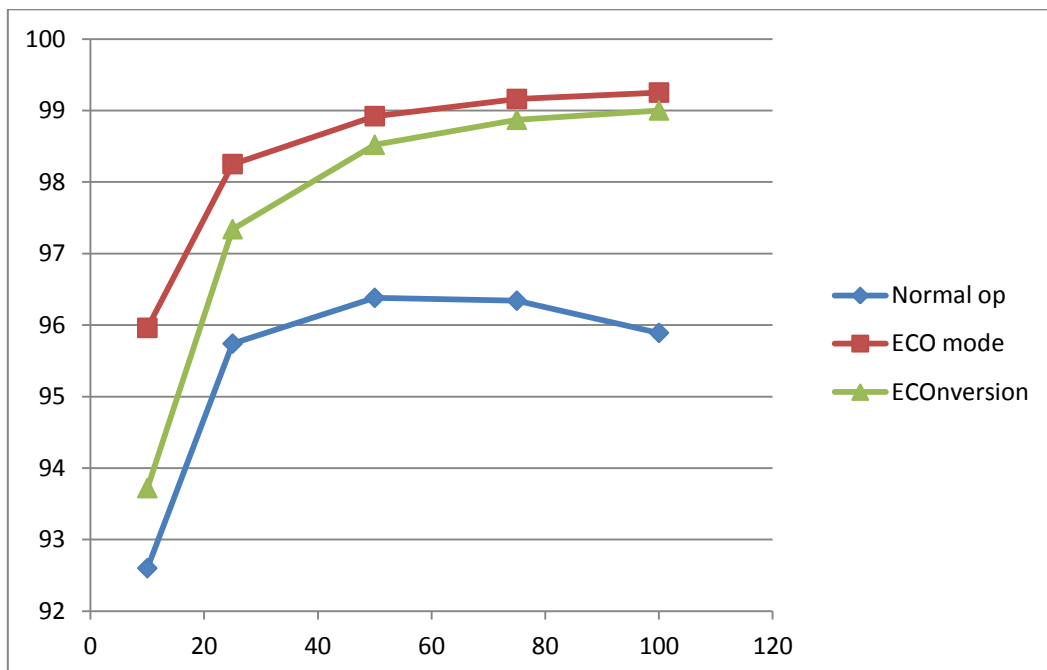

Figure 15: Efficiency plot data derived from Table 2

## [ APPLICATION NOTE #187 ] Galaxy High Efficiency Modes

**Table 2:** Derived from UL test report (10-23-2014) (IEC 62040-3: 2011-3 2nd Edition).  
Test conducted on 200 kVA unit at 400 V.

	<b>Normal op</b>	<b>ECO Mode</b>	<b>ECONversion</b>
<b>Load [%]</b>	<b>Efficiency [%]</b>	<b>Efficiency [%]</b>	<b>Efficiency [%]</b>
10	93.33	96.84	94.54
25	95.86	98.58	97.56
50	96.37	99.09	98.64
75	96.24	99.24	98.97
100	95.72	99.27	99.06

### Output Quality Settings

When operating in ECONversion Mode the system output voltage is following the bypass voltage. To increase system transfer speed when a bypass waveform fault occurs, the bypass voltage fault detector has increased sensitivity. By this, a smaller waveform fault on bypass for a system in ECONversion Mode will result in a transfer to normal operation.

To further improve the system ability to trace the bypass source and avoid transfers from ECONversion Mode to normal operation due to small phase changes, the system frequency slew rate is defaulted to maximum level when in ECONversion Mode. When the UPS returns to normal operation the user adjusted values are used.

A system which is selected to operate in ECONversion Mode should be configured with the widest possible range of operation. Based on this, the FSE must set the system voltage limits and frequency limits as high as possible for the given installation.

### User Interface

ECONversion Mode can be enabled and configured by the customer without the need of an FSE and UPSTuner. The user interface is almost the same as for ECO Mode, only with the addition of one parameter, the 'ECONversion Harmonics Compensator'.

### Setup and configuration

The following parameters can be configured for ECONversion Mode

- **High Efficiency Mode:** Selects which high efficiency mode to be used. Value can be 'None', 'ECO Mode' or 'ECONversion'. Must be set to ECONversion Mode.
- **High Efficiency Mode Setup:** See description in section 'ECO Mode'.
- **ECONversion Harmonics Compensator:** Setting to enable and disable the harmonic compensator feature available in ECONversion Mode.

### Operation

When the UPS is in ECONversion Mode, this will be indicated as both the system and the UPS operation mode in the UPS display and UPSTuner.

The UPS mimic diagram will indicate ECONversion Mode as in Figure 15.

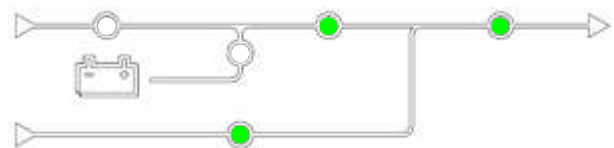

**Figure 16:** Mimic diagram indication of ECONversion Mode.

## Appendix A

### ECONversion efficiency compared to leading load

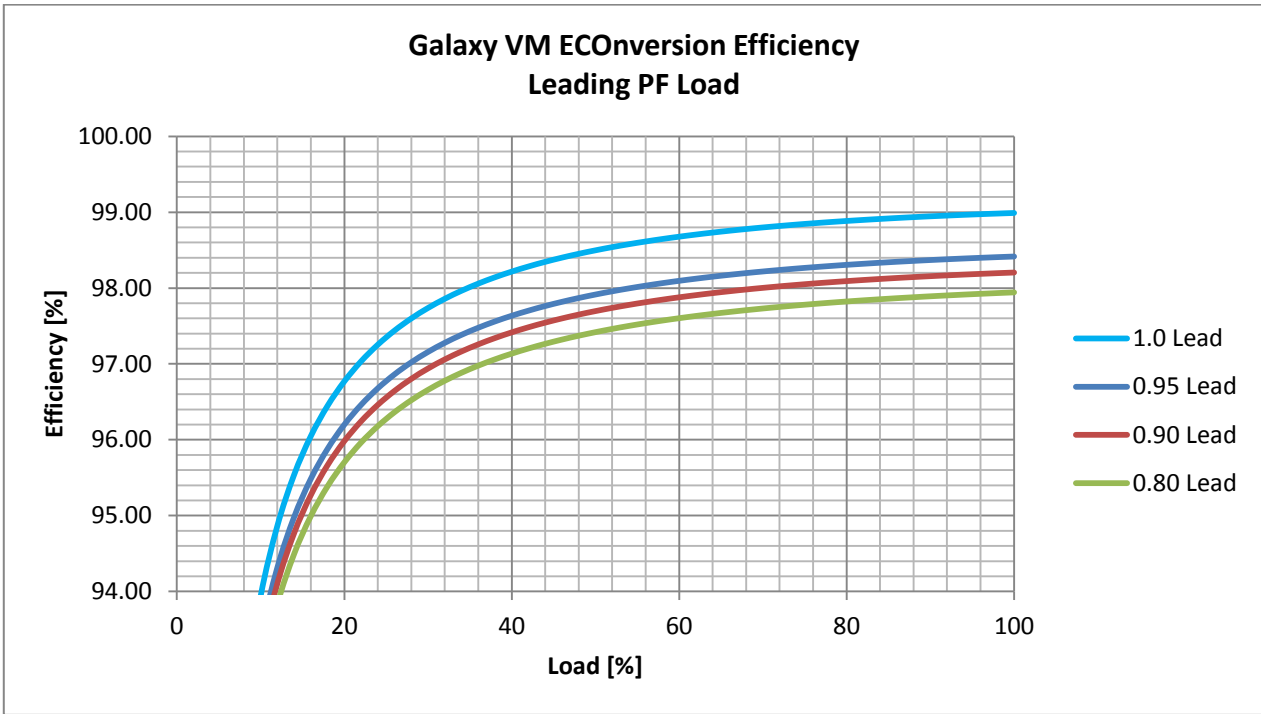

Figure 17: System efficiency related to leading load PF 1.00 0.95 0.90 0.80.

### ECONversion efficiency compared to lagging load

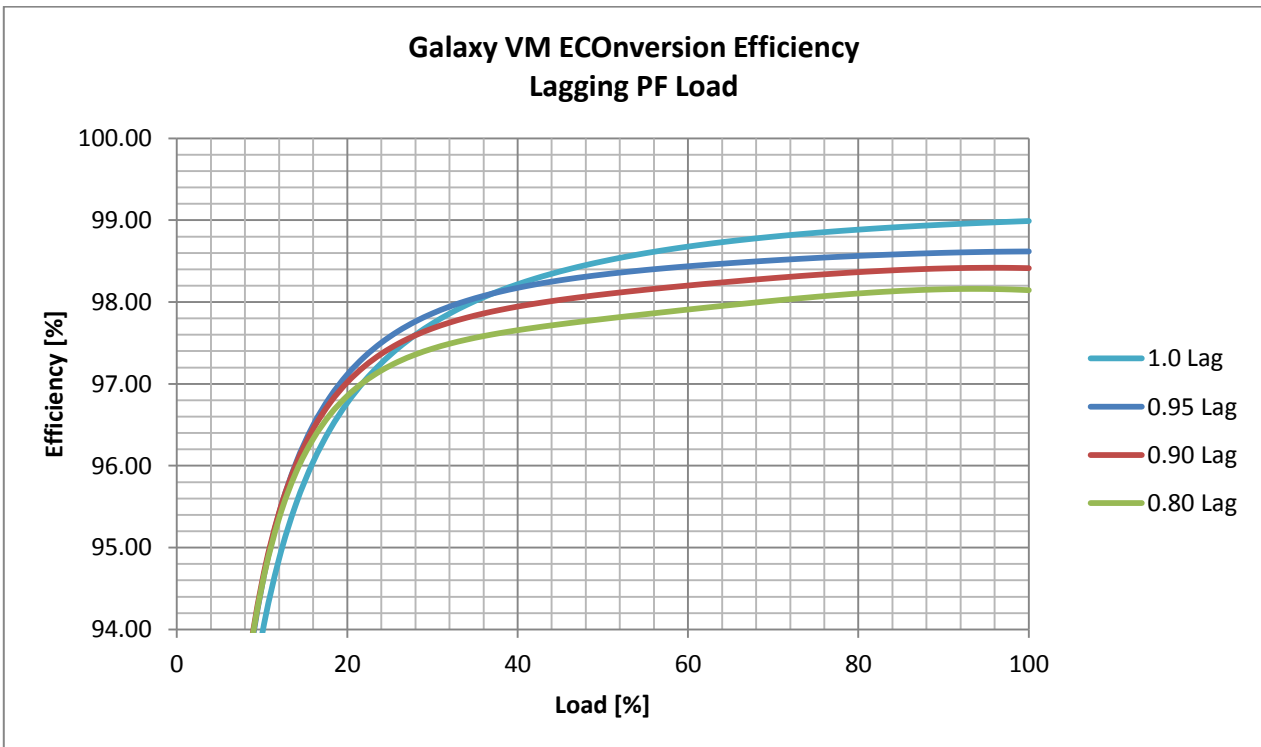

Figure 18: System efficiency related to lagging load PF 1.00 0.95 0.90 0.80.

ECONversion efficiency compared to harmonic load

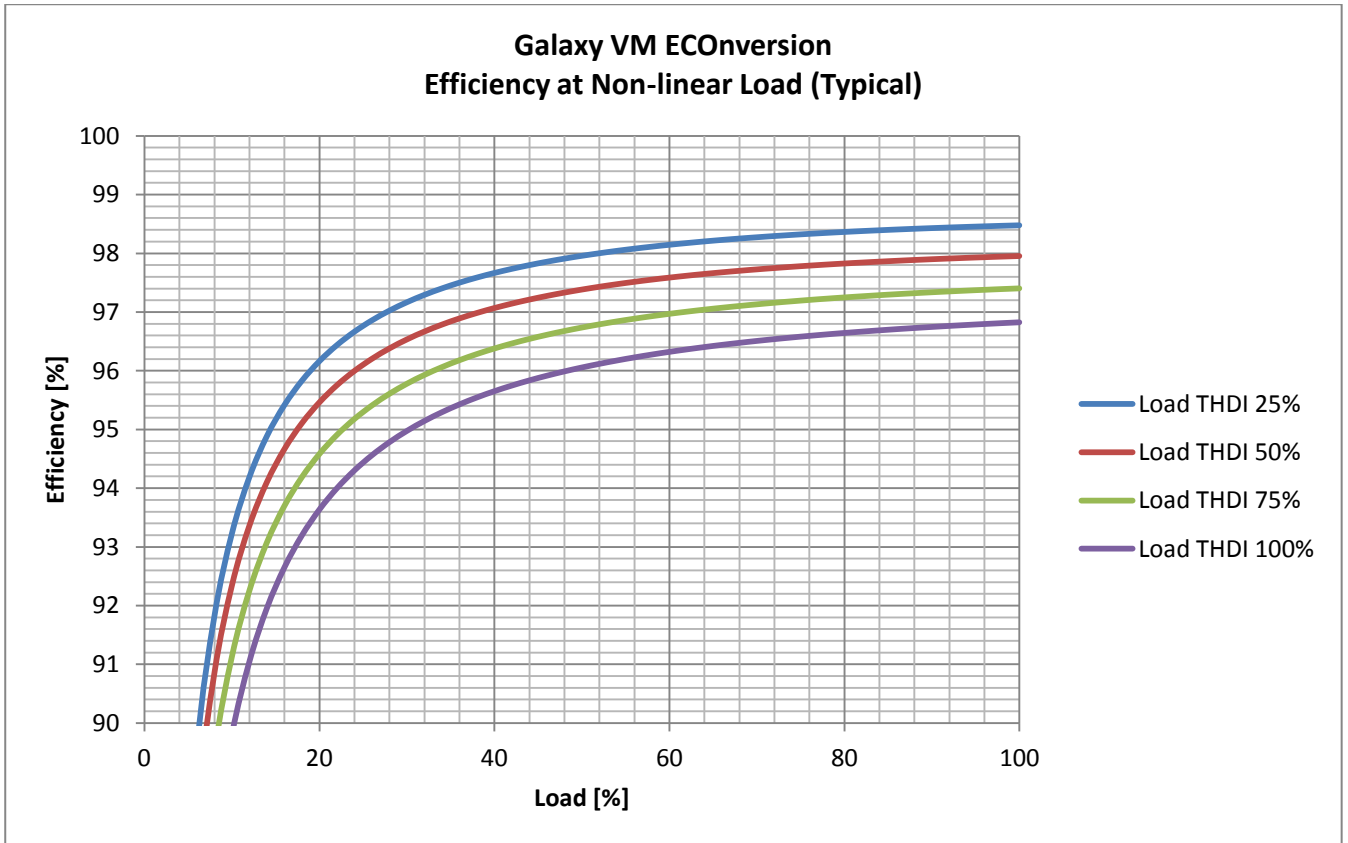

Figure 19: System efficiency relate to harmonic content.